



PRODUCT OVERVIEW

METO[®]

***PRICE MARKING AND
MERCHANDISING SOLUTIONS***



www.meto.com

MERCHANDISING SOLUTIONS (OVERVIEW)

HAND LABELER

METO EAGLE / METO ProLine tools	6 – 19
METO dispenser	20 – 21
METO paginating tools	22 – 23
METO alpha / Fixprint tools	24 – 25
METO consumables/ink rolls	26 – 27

LABELS

METO standard label formats	28 – 30
METO special label formats	31 – 32
METO label colors	33
METO adhesives	34
METO cuts and perforations	35

PRICE CASSETTES/PRICE DISPLAYS

Price cassette PromoSign	
– fruit & vegetables	49
– accessories PromoSign fruit & vegetables	50 – 52
– service counter	52 – 54
PromoSign/PromoLabel cassettes	
– beverage department	55 – 56
– accessories beverage department	56 – 57
Price cassette PromoLabel	
– service counter & shelf	58 – 59
PromoDisplay	60
– accessories PromoSign/PromoLabel	61 – 63
Price cards & fixings	64 – 66

FIXING SOLUTIONS

DecoLine suspension tube	67
– accessories DecoLine suspension tube	68 – 69
Suspension rail	70
– accessories suspension rail	70
PosterLine	71
– accessories PosterLine	71
Ceiling fixtures	72 – 75

SHELF PRESENTATION SOLUTIONS

Shelf presentation system Optisell 1	99 – 101
Shelf presentation system Optisell 2	101 – 104
– accessories shelf presentation systems	105 – 106
Order entry profiles	107
Shelf edge profiles	108
– accessories profiles	109

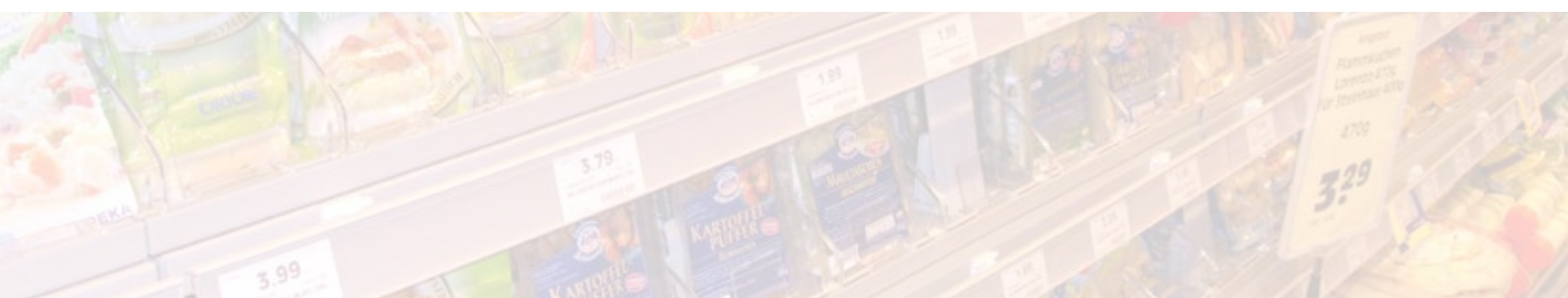

CUSTOMER FLOW MANAGEMENT

Turn-O-Matic Classic & accessories	37 – 41
TOM touch+ & accessories	42 – 43
HappyOrNot	44 – 45

FASTENERS AND ACCESSORIES

Fasteners & accessories	46 – 47
-------------------------	---------

FRAMING SOLUTIONS

Plastic frames	76
– accessories plastic frames	77 – 82
Frame stands	83
– accessories frame stands	84 – 85
List holders	86
Transparent poster covers	87 – 88
Plastic poster cover	88
Aluminium snap frames	89
Pavement stands	90 – 91
Replacement cover foils	92

CREATIVE DISPLAY SOLUTIONS

Perforated label sheets	93
Poster paper / Carton	94
Chalk boards	94
Writing kits / Ink	95 – 97

SHOPPING CONVENIENCE

Shopping baskets	98
------------------	----

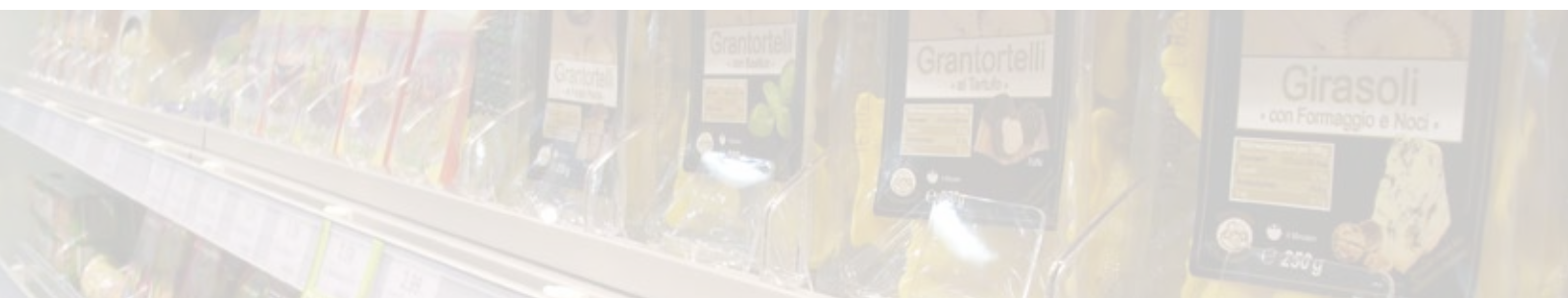

ABOUT METO

EXCELLENT MERCHANDISE IDENTIFICATION AND LABELING METO – A STRONG BRAND

Innovation is all part of our company traditions. Products bearing the METO brand name have been available since 1918. The first handlabeler from the company revolutionised pricing operations in 1959. This marked the first in a long line of products which were to have a lasting influence on the market. In 2016 METO became a business unit of CCL Industries Inc. The brand name has been retained and continues to stand for the familiar high standard of quality. As an internationally operative group we are a global leader in labeling, identification and sales promotion systems.

We offer integrated system solutions and firstclass services for a smooth flow of goods throughout the supply chain.

We are a competent partner to retail, industry and the service sector.



HAND LABELING SOLUTIONS



INTELLIGENT TECHNOLOGY IN EACH TOOL – FOR ALL DEMANDS THE RIGHT LABEL

Trust our experience of more than 55 years. We offer the right hand labeler for every need e.g. industry-specific marking solutions, as for the sterilisation of medical equipment, the weatherproof outdoor marking or labeling in industrial production.





HAND LABELER

METO EAGLE S



Example: tool print / preprint

EAGLE S 622

6 digits for coding or price marking
Label format: 22 x 12 mm

Height of the digits: 3.0 / 5.0 mm
Height of preprint: 4.0 mm

Art. no.: 9391212

Quantity per unit: 1



Example: tool print / preprint

EAGLE S 526

5 digits for price marking
Label format: 26 x 12 mm

Height of the digits: 5.0 mm
Height of preprint: 4.0 mm

Art. no.: 9391836

Quantity per unit: 1



EAGLE S 626

6 digits for price marking
Label format: 26 x 12 /
26 x 16 mm

Height of the digits: 5.0 mm
Height of preprint: 4.0 or 4.0 / 2.0 mm

Art. no.: 9391200 transport 26 x 12 mm

Quantity per unit: 1



Art. no.: 9391840 transport 26 x 16 mm

Quantity per unit: 1



Examples: tool print / preprint

Our handlabeler are also available with other currency signs and in individual device combinations.

METO EAGLE S

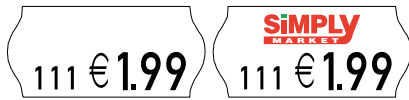

Example: tool print / preprint

EAGLE S 726

7 digits for coding and price marking
Label format: 26 x 12 mm

Height of the digits: 3.0 / 5.0 mm
Height of preprint: 4.0 mm

Art. no.: 9391837

Quantity per unit: 1



Example: tool print / preprint

EAGLE S 826 3/5

8 digits for coding and price marking
Label format: 26 x 12 mm

Height of the digits: 3.0 / 5.0 mm
Height of preprint: 4.0 mm

Art. no.: 9391208

Quantity per unit: 1



Example: tool print / preprint

EAGLE S 826 4/4

8 digits for coding and price marking
Label format: 26 x 12 mm

Height of the digits: 3.0 / 5.0 mm
Height of preprint: 4.0 mm

Art. no.: 9391838

Quantity per unit: 1

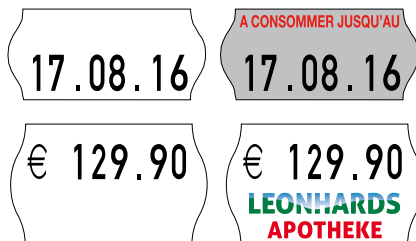

Examples: tool print / preprint

EAGLE S 826 8 x 5

8 digits for coding, date coding or price marking
Label format: 26 x 12 /
26 x 16 mm

Height of the digits: 5.0 mm
Height of preprint: 4.0 or 4.0 / 2.0 mm

Art. no.: 9391209 transport 26 x 12 mm

Quantity per unit: 1

Art. no.: 9391841 transport 26 x 16 mm

Quantity per unit: 1



Example: tool print / preprint

EAGLE S 1026 10 x 4

10 digits for coding, date coding or price marking
Label format: 26 x 12 mm

Height of the digits: 4.3 mm
Height of preprint: 4.0 mm

Art. no.: 9391839

Quantity per unit: 1

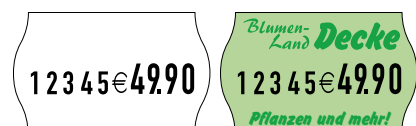

Example: tool print / preprint

EAGLE S 1026 5/5

10 digits for coding and price marking
Label format: 26 x 16 mm

Height of the digits: 3.0 / 4.3 mm
Height of preprint: 4.0 / 2.0 mm

Art. no.: 9391842

Quantity per unit: 1



METO EAGLE M

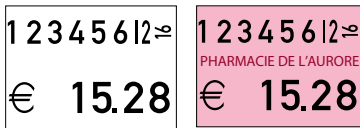

Example: tool print / preprint

EAGLE M 1426 8/6

14 (8/6) digits for coding and price marking
Label format: 21.6 x 16, 26 x 16 mm

Height of the digits: UL*: 3.0 mm, LL**: 4.0 mm
Height of preprint: 2.7 mm

Art. no.: 9391815

Quantity per unit: 1

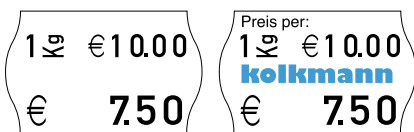

Example: tool print / preprint

EAGLE M 1426 UPM***

14 (8/6) digits for price marking and basic price (unit price marking)
Label format: 21.6 x 16, 26 x 16 mm

Height of the digits: UL: 3.0 mm, LL: 3.0 / 4.3 mm
Height of preprint: 1.0 / 2.7 mm

Art. no.: 9391816

Quantity per unit: 1

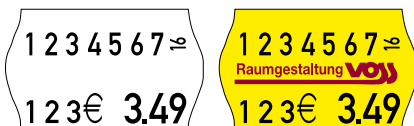

Example: tool print / preprint

EAGLE M 1626 8/8

16 (8/8) digits for coding and price marking
Label format: 21.6 x 16, 26 x 16 mm

Height of the digits: UL: 3.0 mm, LL: 3.0 / 4.3 mm
Height of preprint: 2.7 mm

Art. no.: 9391703

Quantity per unit: 1

*UL: upper line

**LL: lower line

***UPM = Unit price marking

METO EAGLE M

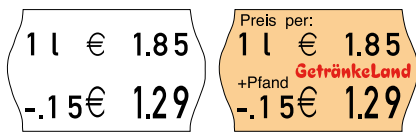

Example: tool print / preprint

EAGLE M 1626 UPM

16 (8/8) digits for coding, price marking and basic price (unit price marking)

Label format: 21.6 x 16,
26 x 16 mm

Height of the digits: UL: 3.0 mm,

LL: 3.0 / 4.3 mm

Height of preprint: 1.0 / 2.7 mm

Art. no.: 9391705

Quantity per unit: 1

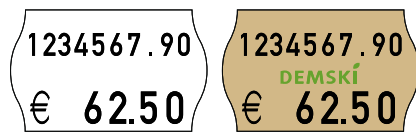

Example: tool print / preprint

EAGLE M 1626 10/6

16 (10/6) digits for coding and price marking

Label format: 21.6 x 16,
26 x 16 mm

Height of the digits: UL: 3.0 mm

LL: 4.0 mm

Height of preprint: 1.0 / 2.7 mm

Art. no.: 9391843

Quantity per unit: 1

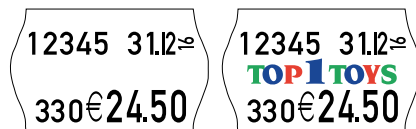

Example: tool print / preprint

EAGLE M 1826 10/8

18 (10/8) digits for coding, date coding and price marking

Label format: 21.6 x 16,
26 x 16 mm

Height of the digits: UL: 3.0 mm

LL: 3.0 / 4.3 mm

Height of preprint: 1.0 / 2.7 mm

Art. no.: 9391844

Quantity per unit: 1

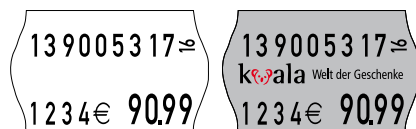

Example: tool print / preprint

EAGLE M 2026

20 (10/10) digits for coding, date coding and price marking

Label format: 21.6 x 16,
26 x 16 mm

Height of the digits: UL: 3.0 mm

LL: 3.0 / 4.3 mm

Height of preprint: 2.7 mm

Art. no.: 9391845

Quantity per unit: 1

Our handlabeler are also available with other currency signs and in individual device combinations.



METO EAGLE L

385/4067/021

€15.28

385/4067/021

€15.28

top Sound

Example: tool print / preprint

EAGLE L 1832 CP*

18 (12/6) digits for coding and price marking

Label format: 25 x 19, 32 x 19 mm

Height of the digits: UL: 3.0 mm

LL: 5.7 mm

Height of preprint: 5.0 mm

Art. no.: 9446637

Quantity per unit: 1

385/4067/021

€151.28

385/4067/021

€151.28

top Sound

Example: tool print / preprint

EAGLE L 1832 CP

18 (12/6) digits for coding and price marking

Label format: 25 x 19, 32 x 19 mm

Height of the digits: UL: 3.0 mm

LL: 5.7 mm

Height of preprint: 5.0 mm

Art. no.: 9446274

Quantity per unit: 1

4521-553/220

€65.82

4521-553/220

€65.82

DENNER EXPRESS

Example: tool print / preprint

EAGLE L 1832 IP**

18 (12/6) digits for coding and price marking

Label format: 25 x 19, 32 x 19 mm

Height of the digits: UL: 3.0 mm

LL: 5.7 mm

Height of preprint: 1.5 / 4.0 mm

Art. no.: 9471361

Quantity per unit: 1

*CP = Consecutive printing

**IP = Immediate printing

METO EAGLE L

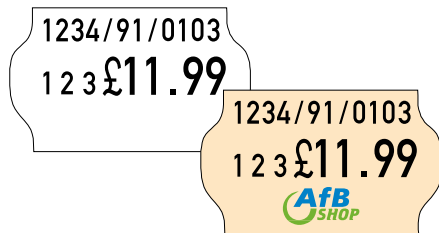

Example: tool print / preprint

EAGLE L 2132 CP

21 (12/9) digits for coding and price marking

Label format: 25 x 19, 32 x 19 mm

Height of the digits: UL: 3.0 mm

LL: 3.0 / 5.0 mm

Height of preprint: 5.0 mm

Art. no.: 9446703

Quantity per unit: 1

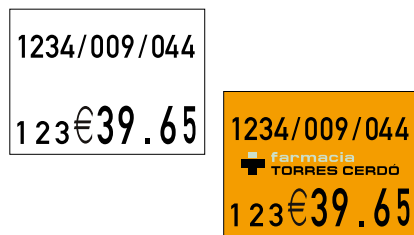

Example: tool print / preprint

EAGLE L 2132 IP

21 (12/9) digits for coding and price marking

Label format: 25 x 19, 32 x 19 mm

Height of the digits: UL: 3.0 mm

LL: 3.0 / 5.0 mm

Height of preprint: 4.0 mm

Art. no.: 9463329

Quantity per unit: 1



Example: tool print / preprint

EAGLE L 2132 UPM CP

21 (12/9) digits for coding, price marking

and basic price (unit price marking)

Label format: 25 x 19, 32 x 19 mm

Height of the digits: UL: 3.0 mm

LL: 3.0 / 5.0 mm

Height of preprint: 1,5 / 5.0 mm

Art. no.: 9455071

Quantity per unit: 1



Example: tool print / preprint

EAGLE L 2132 UPM IP

21 (12/9) digits for coding, price marking

and basic price (unit price marking)

Label format: 25 x 19, 32 x 19 mm

Height of the digits: UL: 3.0 mm

LL: 3.0 / 5.0 mm

Height of preprint: 4.0 mm

Art. no.: 9455077

Quantity per unit: 1

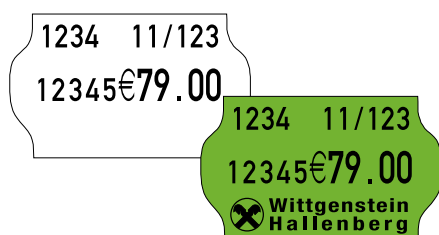

Example: tool print / preprint

EAGLE L 2332 CP

23 (12/11) digits for coding and price marking

Label format: 25 x 19, 32 x 19 mm

Height of the digits: UL: 3.0 mm

LL: 3.0 / 4.3 mm

Height of preprint: 5.0 mm

Art. no.: 9446700

Quantity per unit: 1

Our handlabeler are also available with other currency signs and in individual device combinations.

METO EAGLE L

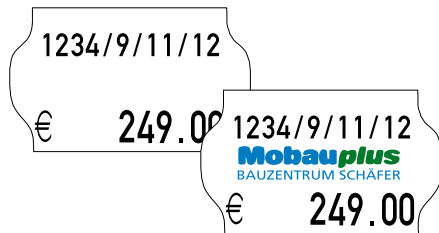

Example: tool print / preprint

EAGLE L 2332 IP

23 (12/11) digits for coding and price marking

Label format: 25 x 19, 32 x 19 mm

Height of the digits: UL: 3.0 mm

LL: 3.0 / 4.3 mm

Height of preprint: 4.0 mm

Art. no.: 9455074

Quantity per unit: 1

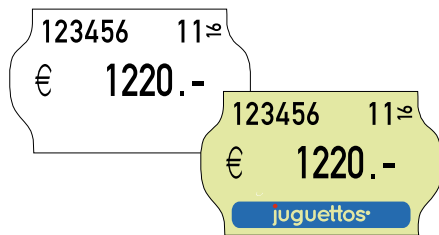

Example: tool print / preprint

EAGLE L 2332 DT CP

23 (12/11) digits for coding, date coding and price marking

Label format: 25 x 19, 32 x 19 mm

Height of the digits: UL: 3.0 mm

LL: 4.3 mm

Height of preprint: 5.0 mm

Art. no.: 9455100

Quantity per unit: 1

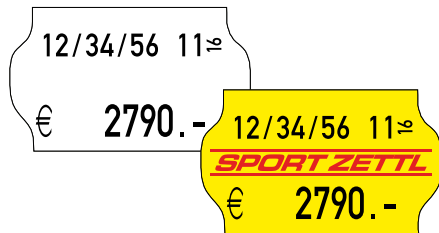

Example: tool print / preprint

EAGLE L 2332 DT IP

23 (12/11) digits for coding, date coding and price marking

Label format: 25 x 19, 32 x 19 mm

Height of the digits: UL: 3.0 mm

LL: 4.3 mm

Height of preprint: 4.0 mm

Art. no.: 9466066

Quantity per unit: 1

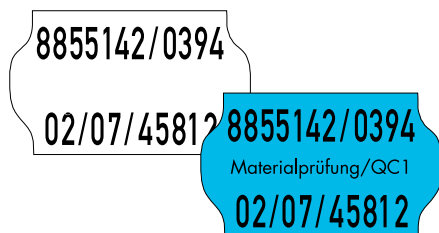

Examples: tool print / preprint

EAGLE L 2332 Industry

23 (12/11) digits for industrial labeling or coding

Label format: 25 x 19, 32 x 19 mm

Height of the digits: UL: 4.3 mm

LL: 4.3 mm

Height of preprint: 4.0 mm

Art. no.: 9455105

Quantity per unit: 1

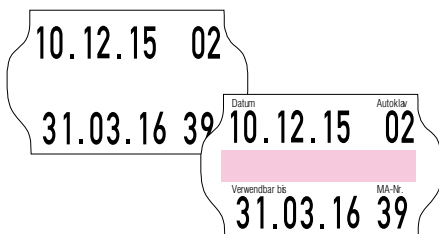

Examples: tool print / preprint

Our handlabeler are also available with other currency signs and in individual device combinations.



METO EAGLE XL



Example: tool print / preprint

EAGLE XL 729/20

7 digits for price marking
Label format: 29 x 20 mm

Height of the digits: 5.7 mm
Height of preprint: 8.0 mm

Art. no.: on request

Quantity per unit: 1



Example: tool print / preprint

EAGLE XL 729/28

7 digits for price marking
Label format: 29 x 28 mm

Height of the digits: 8.3 mm
Height of preprint: 14.0 mm

Art. no.: 9445535

Quantity per unit: 1

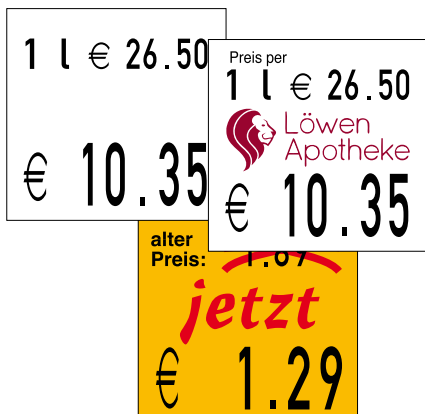

Example: tool print / preprint

EAGLE XL 1829 UPM

18 (11/7) digits for price marking and
basic price (unit price marking)
Label format: 29 x 28 mm

Height of the digits: UL: 4.0 mm
LL: 8.3 mm
Height of preprint: 1.0/7.0 mm

Art. no.: 9445760

Quantity per unit: 1

METO EAGLE XL

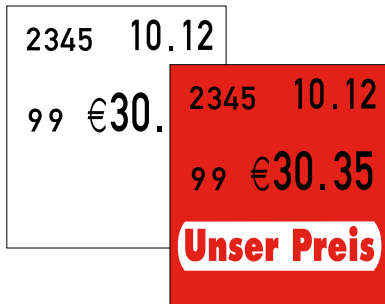

Example: tool print / preprint

EAGLE XL 2029

20 (11/9) digits for coding, price marking and basic price (unit price marking)
Label format: 29 x 32 mm

Height of the digits: UL: 4.3 mm
LL: 3.0/5.0 mm
Height of preprint: 4.0/14.0 mm

Art. no.: 9455469

Quantity per unit: 1

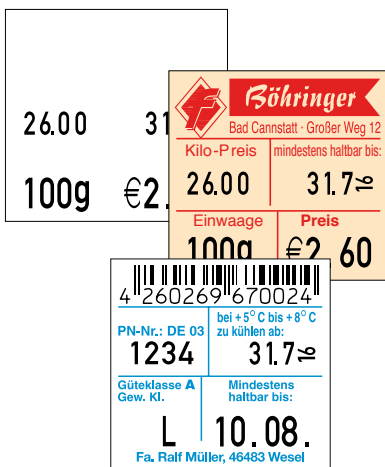

Example: tool print / preprint

EAGLE XL 2229 FIR*

22 (11/11) digits for coding, labeling in accordance with legal requirements
Label format: 29 x 28 mm

Height of the digits: 3.0/4.0 mm
Height of preprint: 10.0/3.0 mm

Art. no.: 9455461

Quantity per unit: 1

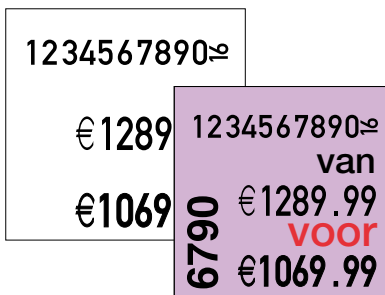

Example: tool print / preprint

EAGLE XL 2929 CPM**

29 (11/9/9) digits for coding or for price comparisons (CPM)
Label format: 29 x 28 mm

Height of the digits: 3.0/4.0/4.3 mm
Height of preprint: 2.5/3.5/3.5 mm
(depending on printhead position)

Art. no.: 9455454

Quantity per unit: 1

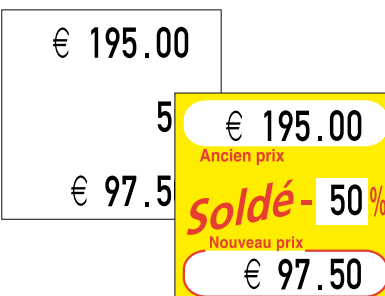

Example: tool print / preprint

EAGLE XL 3329 3x11

33 (11/11/11) digits for coding and price marking
Label format: 29 x 28 mm

Height of the digits: 4.0/4.0/4.0 mm
Height of preprint: 3.5/3.5 mm

Art. no.: 9454769

Quantity per unit: 1

*FIR = Food Information Regulation

**CPM = Comparison price marking

Our handlabeler are also available with other currency signs and in individual device combinations.

METO EAGLE XL

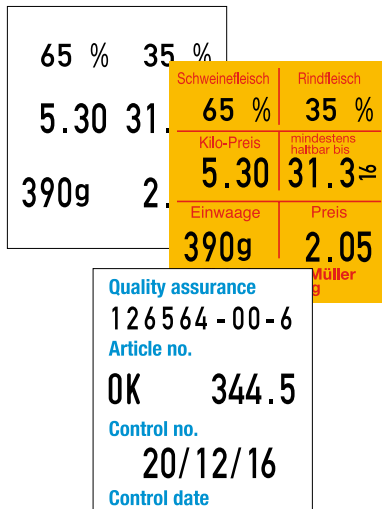

Example: tool print / preprint

EAGLE XL 3329 3/4/4 FIR

33 (11/11/11) for coding, labeling in accordance with legal requirements
Label format: 29 x 32 mm

Height of the digits: 3.0/4.0/4.0 mm
Height of preprint: 1.5/3.5/3.5/4.0 mm
(depending on printhead position)

Art. no.: 9455440

Quantity per unit: 1

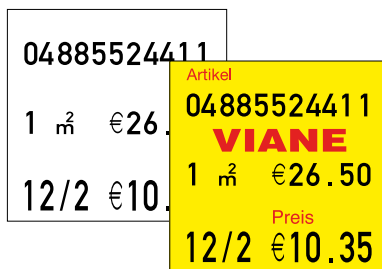

Example: tool print / preprint

EAGLE XL 3329/28 UPM

33 (11/11/11) digits for price marking and basic price (unit price marking)
Label format: 29 x 28 mm

Height of the digits: 3.0/3.0/4.0 mm
Height of preprint: 1.5/4.5/3.5/4.0 mm
(depending on printhead position)

Art. no.: 9455444

Quantity per unit: 1

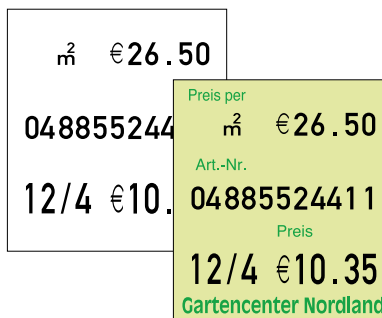

Example: tool print / preprint

EAGLE XL 3329/32 UPM

33 (11/11/11) digits for price marking and basic price (unit price marking)
Label format: 29 x 32 mm

Height of the digits: 3.0/3.0/4.0 mm
Height of preprint: 1.0/4.5/3.5/4.0 mm
(depending on printhead position)

Art. no.: 9455448

Quantity per unit: 1

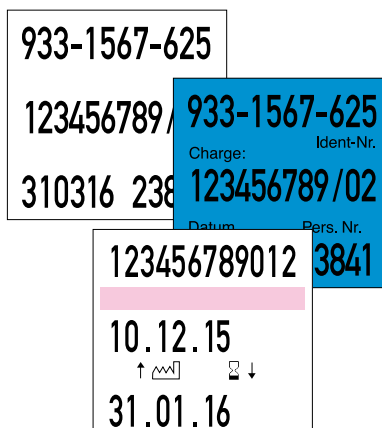

Example: tool print / preprint

EAGLE XL 3629 Industry

36 (12/12/12) digits for industrial labeling
Label format: 29 x 28 mm

Height of the digits: 4.3/4.3/4.3 mm
Height of preprint: 3.5/3.5 mm

Art. no.: 9447202

Quantity per unit: 1

METO®

ProLine



METO PROLINE XXL

ProLine XXL 2136/28

21 (14/7) digits for coding and price marking
Label format: 36 x 28 mm

Height of the digits: 4.3/8.3 mm
Height of preprint: 6.7 mm

Art. no.: 9314012

Quantity per unit: 1



Example: tool print / preprint

ProLine XXL 2236/28

22 (14/8) digits for coding and price marking
Label format: 36 x 28 mm

Height of the digits: 4.3/8.3 mm
Height of preprint: 6.7 mm

Art. no.: 9314010

Quantity per unit: 1

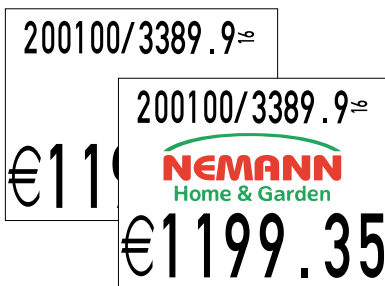

Example: tool print / preprint

ProLine XXL 2836/28

28 (14/14) digits for coding and price marking
Label format: 36 x 28 mm

Height of the digits: 4.3/4.3 mm
Height of preprint: 12 mm

Art. no.: 9314008

Quantity per unit: 1

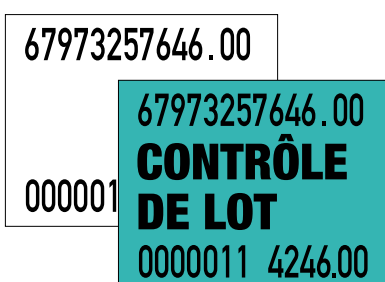

Example: tool print / preprint

METO PROLINE XXL



Example: tool print / preprint

ProLine XXL 2136/35

21 (14/7) digits for coding and price marking

Label format: 36 x 35 mm

Height of the digits: 4.3/8.3 mm
Height of preprint: 4.0/8.0/3.0 mm
(depending on printhead position)

Art. no.: 9314011

Quantity per unit: 1

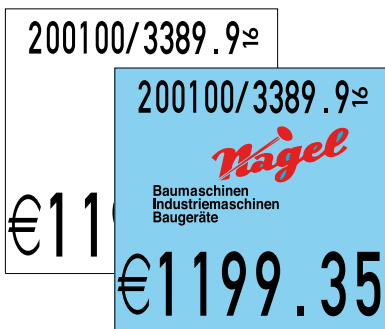

Example: tool print / preprint

ProLine XXL 2236/35

22 (14/8) digits for coding and price marking

Label format: 36 x 35 mm

Height of the digits: 4.3/4.3 mm
Height of preprint: 4.0/8.0/3.0 mm
(depending on printhead position)

Art. no.: 9314009

Quantity per unit: 1

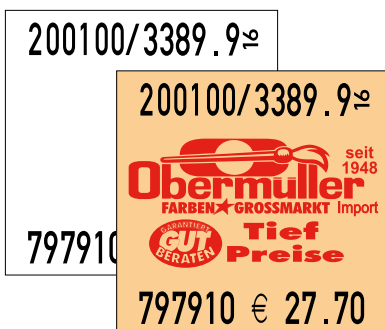

Example: tool print / preprint

ProLine XXL 2836/35

28 (14/14) digits for coding and price marking

Label format: 36 x 35 mm

Height of the digits: 4.3/8.3 mm
Height of preprint: 19.0 mm
(depending on printhead position)

Art. no.: 9314007

Quantity per unit: 1

Our handlabeler are also available with other currency signs and in individual device combinations.

METO®

ProLine



METO PROLINE SECURITY

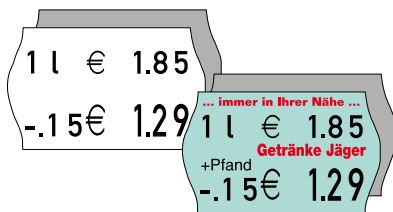

Example: tool print / preprint

ProLine M EM 1626

16 (8/8) digits for basic price (unit price marking)

Label format: 26 x 16 mm
for electronic article surveillance (electromagnetic)

Height of the digits: UL: 3.0 mm
LL: 3.0 / 4.3 mm
Height of preprint: 2.7 mm

Art. no.: 9311740

Quantity per unit: 1

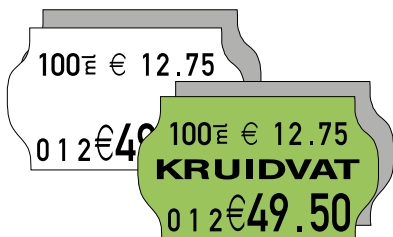

Example: tool print / preprint

ProLine L EM 2132 UPM IP

21 (12/9) digits basic price (unit price marking)

Label format: 32 x 19 mm
for electronic article surveillance (electromagnetic)

Height of the digits: UL: 3.0 mm
LL: 3.0 / 5.0 mm
Height of preprint: 4.0 mm

Art. no.: 9312176

Quantity per unit: 1

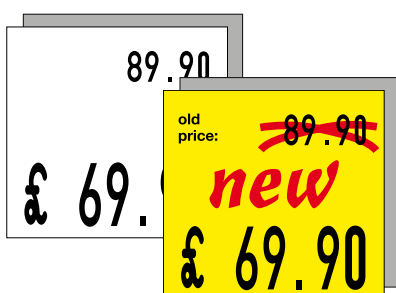

Example: tool print / preprint

ProLine XL EM 1829 UPM

18 (11/7) digits basic price (unit price marking)

Label format: 29 x 28 mm
for electronic article surveillance (electromagnetic)

Height of the digits: UL: 4.0 mm
LL: 8.3 mm
Height of preprint: 7.0 mm

Art. no.: 9313762

Quantity per unit: 1

METO PROLINE SECURITY



Example: tool print / preprint

ProLine XL RF 1524 UPM Micro PST

15 (10/5) digits for basic price
(unit price marking)
Label format: 24 x 25 mm
for electronic article surveillance
(radio-frequency)

Height of the digits: UL: 4.0 mm
LL: 8.3 mm
Height of preprint: 8.0 mm

Art. no.: on request

Quantity per unit: 1



Example: tool print / preprint

ProLine XXL RF 1833 UPM 710

18 (12/6) digits for basic price
(unit price marking)
Label format: 33 x 39 mm
for electronic article surveillance
(radio-frequency)

Height of the digits: UL: 4.0 mm
LL: 8.3 mm
Height of preprint: 7.5/8.0/3.0 mm

Art. no.: 9314557

Quantity per unit: 1

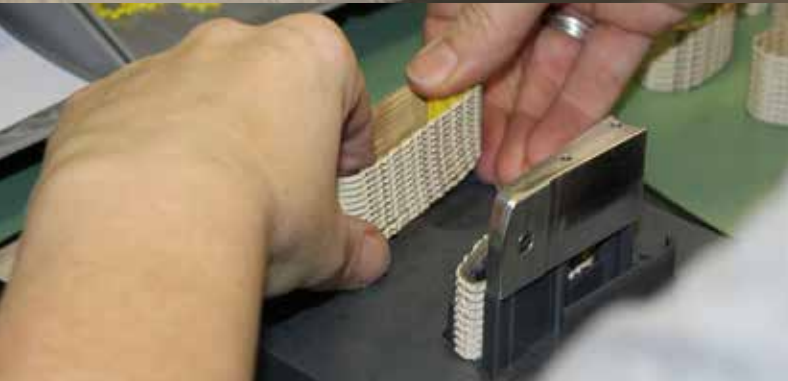

Our handlabeler are also available with other currency signs and in individual device combinations.



EAGLE / PROLINE /
UNIVERSAL DISPENSER

FOR LABEL FORMAT

22 x 12 mm

Art. no.: 9425372

Quantity per unit: 1

22 x 16 mm / 14 mm round

Art. no.: 9425373

Quantity per unit: 1

26 x 12 mm

Art. no.: 9425374

Quantity per unit: 1

26 x 16 mm

Art. no.: 9425375

Quantity per unit: 1

26 x 16 mm (with extended base plate)

Art. no.: 9439276

Quantity per unit: 1

32 x 19 mm

Art. no.: 9447362

Quantity per unit: 1

29 x 28 mm, 20/26 mm round

Art. no.: 9447363

Quantity per unit: 1

29 x 32 mm

Art. no.: 9447366

Quantity per unit: 1



Label examples

DISPENSER



Label examples

FOR LABEL FORMAT

25 x 24 mm RF (MicroPST)

Art. no.: 9467901

Quantity per unit: 1

36 x 28 mm

Art. no.: 8152007

Quantity per unit: 1

36 x 35 mm, 33 mm round

Art. no.: 9314006

Quantity per unit: 1

Variable to 33 mm bandwidth

Art. no.: 8150901

Quantity per unit: 1

Variable to 63 mm bandwidth

Art. no.: 8150902

Quantity per unit: 1

32 x 28 mm thermal labels

Art. no.: 9313557

Quantity per unit: 1

32 x 20 mm thermal labels

Art. no.: 9313565

Quantity per unit: 1

26 x 30 mm roof shape, PP foil

Art. no.: 9468087

Quantity per unit: 1

26 mm round, PE/PP foil

Art. no.: 9468086

Quantity per unit: 1

Rectangular labels, 20 – 100 mm width, 20 – 60 mm height
TOWA APN series

Art. no.: on request

Quantity per unit: 1

Other label formats 20 – 100 mm width, 20 – 60 mm height
TOWA APF series

Art. no.: on request

Quantity per unit: 1



METO EAGLE / METO 2000 / NF 82 PAGINATING TOOLS

54L1234

Example print tool

EAGLE S 722 PA

7 digits, 4.0/3.0 mm

4 consecutive numbers

0 = permanent, without stepping

1 = consecutive after each labels

2 = consecutive after every 2nd label

Label format: 22 x 12 mm

Art. no.: 9439601

Also available as pneumatic (compressed air) tool

Quantity per unit: 1

123~~4~~1234

Example print tool

EAGLE S 822 PA

8 digits, 3.0/4.0 mm

4 consecutive numbers

Stepping possibilities 0 - 1 - 2

Label format: 22 x 12 mm

Art. no.: 9442281

Also available as pneumatic (compressed air) tool

Quantity per unit: 1

ABCDxxL123

Example print tool

EAGLE S 1026 PA

10 digits, 4.0/3.0/4.0 mm

3 consecutive numbers

Stepping possibilities 0 - 1 - 2

Label format: 26 x 12 mm

Art. no.: 9442354

Also available as pneumatic (compressed air) tool

Quantity per unit: 1

PAGINATING TOOLS



Example print tool

2207 PA light

7 digits, 3.0/4.5/2.6 mm

4 consecutive numbers

Stepping possibilities 0 - 1 - 2

Label format: 22 x 12 mm

Art. no.: 9317014

Quantity per unit: 1

Art. no.: 8126751

2207 PA metal (pneumatic tool)

Quantity per unit: 1

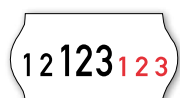

Example print tool

2208 PA light

8 digits, 3.0/4.5/2.6 mm

3 consecutive numbers

Stepping possibilities 0 - 1

Label format: 22 x 12 mm

Art. no.: 9317008

Quantity per unit: 1

Art. no.: 8126760

2208 PA metal (pneumatic tool)

Quantity per unit: 1

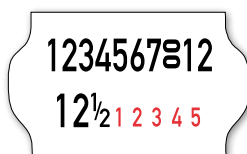

Example print tool

NF 82 PA 1832

UL: 10 digits, 4,3 mm, LL: 8 digits, 4.5/2.6 mm

5 consecutive numbers

Stepping possibilities 0 - 1 - 2

Label format: 32 x 19 mm

Art. no.: 8140500

Quantity per unit: 1



All paginating tools print in black color.

The consecutive numbering of all tool models is shown in **red** here.



mindestens haltbar bis:
kontrolliert am:
abgepackt am:
Rückstellmuster vom:
geöffnet am:
eingelagert am:
ausgelagert am:
zu verbrauchen bis:
hergestellt am:
eingefroren am:
aufgetaut am:
kühlt lagern +2°C bis +7°C

METO EAGLE ALPHA / FIXPRINT

ANGEBOT

€ 99.99

Example print tool

EAGLE M 1426 Alpha

14 (8/6) digits for alphanumeric coding and/or price coding
Label format: 26 x 16 mm

Height of the digits: UL: 3.0 mm
LL: 3.0 / 4.3 mm

Art. no.: 9391862

Quantity per unit: 1

ZOTTOMOX

1 23 € 99.99

Example print tool

EAGLE M 1626 Alpha

16 (8/8) digits for alphanumeric coding and/or price coding
Label format: 26 x 16 mm

Height of the digits: UL: 4.3 mm
LL: 3.0 / 4.3 mm

Art. no.: 9391863

Quantity per unit: 1

LAGERWARE

12345-78

Example print tool

EAGLE M 1826 Alpha

18 (10/8) digits for alphanumeric coding and/or price coding
Label format: 26 x 16 mm

Height of the digits: UL: 4.3 mm
LL: 4.3 mm

Art. no.: 9391864

Quantity per unit: 1



Example print tool

EAGLE M 2026 Alpha

20 (10/10) digits for alphanumeric coding and/or price coding
Label format: 26 x 16 mm

Height of the digits: UL: 4.3 mm
LL: 3.0 / 4.3 mm

Art. no.: 9391865

Quantity per unit: 1

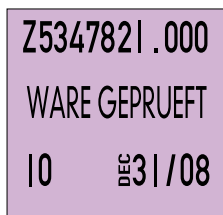

Example print tool

ProLine XL 3629 Alpha

36 (12/12/12) digits for alphanumeric coding and/or price coding
Label format: 29 x 28 mm

Height of the digits: UL: 4.3 mm
ML: 4.3 mm, LL: 4.3 mm

Art. no.: 9313568

Quantity per unit: 1

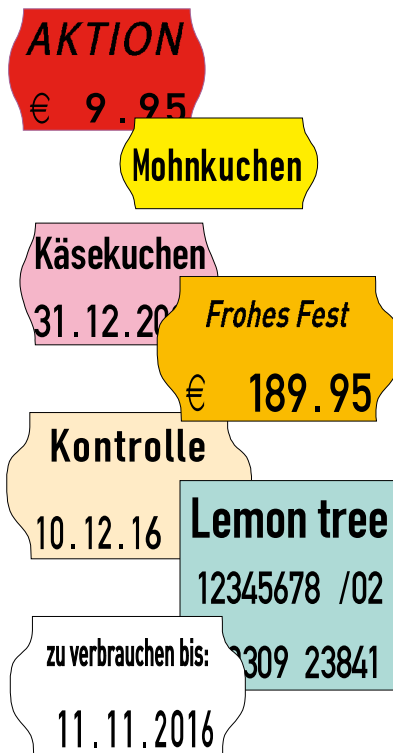

Example print tool

EAGLE Fixprint tools

Changeable terms and price marking / coding in one single tool

Available for tool types M, L, XL, XXL
Especially recommended as HACCP, campaign and event tool. Content of print band set adjustable to customer specification.

Art. no.: on request

Quantity per unit: 1



Example printband



METO EAGLE /
METO PROLINE INK ROLLS

INK ROLLS



EAGLE S/M Standard

Art. no.: 9321597

Quantity per unit: 5

EAGLE S/M PA

Art. no.: 9440952

Quantity per unit: 5

EAGLE S/M UV

Art. no.: 9321605

Quantity per unit: 5

EAGLE S/M GIANT (G626)

Art. no.: 9321598

Quantity per unit: 5



ProLine S/M Standard

Art. no.: 8852660

Quantity per unit: 5

ProLine S/M PA

Art. no.: 8852530

Quantity per unit: 5

ProLine S/M UV

Art. no.: 8853230

Quantity per unit: 5

ProLine S/M GIANT (G626)

Art. no.: 8854335

Quantity per unit: 5

INK ROLLS

Ink rolls



EAGLE / ProLine L/XL Standard

Art. no.: 8873170

Quantity per unit: 2



EAGLE / ProLine XL UV

Art. no.: 8873195

Quantity per unit: 2

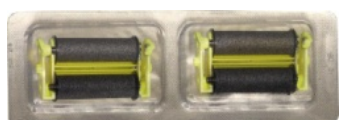

EAGLE / ProLine L/XL
GIANT (729/1829)

Art. no.: 9323062

Quantity per unit: 2

ProLine Security XL

Art. no.: 8873214

Quantity per unit: 2

ProLine XXL Standard

Art. no.: 8888190

Quantity per unit: 2

ProLine XXL UV

Art. no.: 9324008

Quantity per unit: 2

2207/2208 PA

Art. no.: 8852483

Quantity per unit: 1

1832 PA

Art. no.: 8864301

Quantity per unit: 1

Please note that original METO ink rolls are durable up to 12 months in packed condition (blister pack).





LABELS

STANDARD LABEL FORMATS

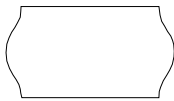

22 x 12 mm

Wavy edge labels 22 x 12

Label format: 22 x 12 mm

Please refer to our METO color chart

Suitable for handlabeler: EAGLE, ProLine S

1 carton, 42 rolls per 1,500 labels

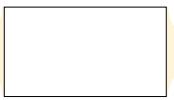

21,6 x 12 mm

Rectangular labels 21.6 x 12

Label format: 21.6 x 12 mm

Please refer to our METO color chart

Suitable for handlabeler: EAGLE, ProLine S

(custom base plate necessary)

1 carton, 36 rolls per 1,500 labels



26 x 12 mm

Wavy edge labels 26 x 12

Label format: 26 x 12 mm

Please refer to our METO color chart

Suitable for handlabeler: EAGLE, ProLine S

1 carton, 36 rolls per 1,500 labels



21,6 x 16 mm

Rectangular labels 21.6 x 16

Label format: 21.6 x 16 mm

Please refer to our METO color chart

Suitable for handlabeler: EAGLE, ProLine S/M

(custom base plate necessary)

1 carton, 36 rolls per 1,200 labels

STANDARD LABEL FORMATS



26 x 16 mm

Wavy edge labels 26 x 12

Label format: 26 x 16 mm

Please refer to our METO color chart

Suitable for handlabeler: EAGLE, ProLine S/M

1 carton, 36 rolls per 1,200 labels

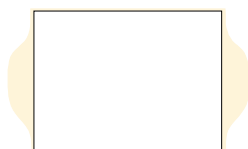

25 x 19 mm
(from 32 x 19 mm)

Rectangular labels 25 x 19

Label format: 25 x 19 mm

Please refer to our METO color chart

Suitable for handlabeler: EAGLE, ProLine L

1 carton, 30 rolls per 1,000 labels

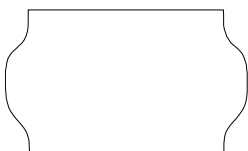

32 x 19 mm

Wavy edge labels 32 x 19

Label format: 32 x 19 mm

Please refer to our METO color chart

Suitable for handlabeler: EAGLE, ProLine L

1 carton, 30 rolls per 1,000 labels



29 x 20 mm
(from 32 x 19 mm)

Rectangular labels 29 x 20

Label format: 29 x 20 mm

Please refer to our METO color chart

Suitable for handlabeler: EAGLE, ProLine L

1 carton, 30 rolls per 1,000 labels

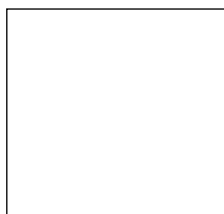

29 x 28 mm

Rectangular labels 29 x 28

Label format: 29 x 28 mm

Please refer to our METO color chart

Suitable for handlabeler: EAGLE, ProLine XL

1 carton, 30 rolls per 700 labels



29 x 32 mm

Rectangular labels 29 x 32

Label format: 29 x 32 mm

Please refer to our METO color chart

Suitable for handlabeler: EAGLE, ProLine XL

1 carton, 30 rolls per 600 labels



36 x 28 mm

Rectangular labels 36 x 28

Format: 36 x 28 mm

Please refer to our METO color chart

Suitable for handlabeler: ProLine XXL

1 carton, 24 rolls per 700 labels

STANDARD LABEL FORMATS

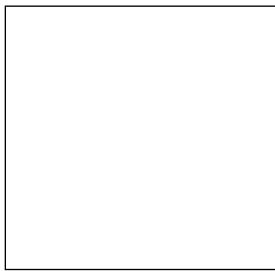

36 x 35 mm

Rectangular labels 36 x 35 mm

Label format: 36 x 35 mm

Please refer to our METO color chart

Suitable for handlabeler: ProLine XXL

1 carton, 24 rolls per 500 labels

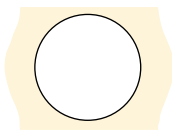

14 mm round

Labels 14 mm round

Label format: 14 mm Ø

Please refer to our METO color chart

Suitable for handlabeler: EAGLE, ProLine M

1 carton, 42 rolls per 1,200 labels

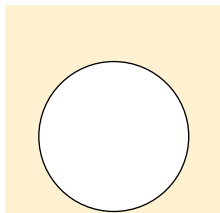

20 mm round

Labels 20 mm round

Label format: 20 mm Ø

Please refer to our METO color chart

Suitable for handlabeler: EAGLE, ProLine XL

1 carton, 30 rolls per 700 labels

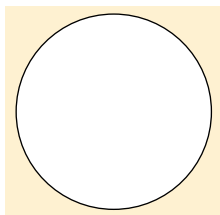

26 mm round

Labels 26 mm round

Label format: 26 mm Ø

Please refer to our METO color chart

Suitable for handlabeler: EAGLE, ProLine XL

1 carton, 30 rolls per 700 labels

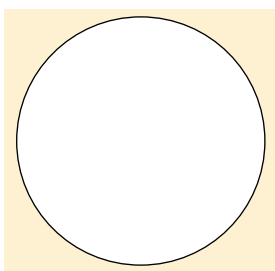

33 mm round

Labels 33 mm round

Label format: 33 mm Ø

Please refer to our METO color chart

Suitable for handlabeler: ProLine XXL

1 carton, 24 rolls per 500 labels

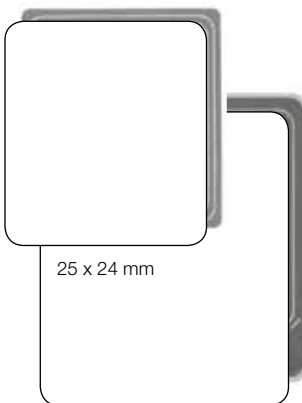

25 x 24 mm

33 x 39 mm

Labels 25 x 24 mm, 2410 EP

Label format: 25 x 24 mm

Suitable for handlabeler: ProLine XL RF

1 carton, 8 / 15 / 30 rolls per 250 labels

Labels 33 x 39 mm, 710 EP





Label format: 33 x 39 mm

Suitable for handlabeler: ProLine XXL RF

1 carton, 10 rolls per 200 labels

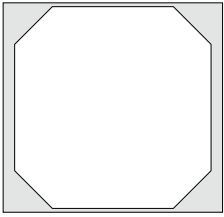
In addition to these standard formats is a variety of other label sizes available.

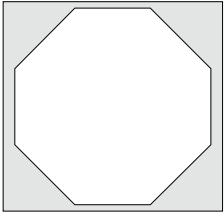
SPECIAL LABEL FORMATS

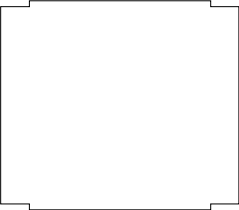
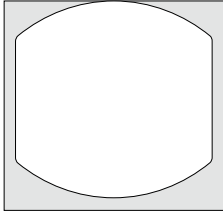
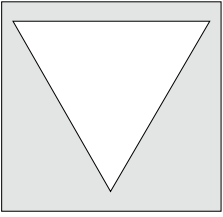
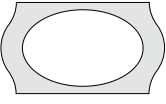
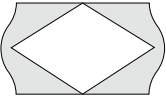
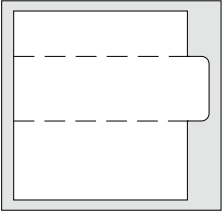
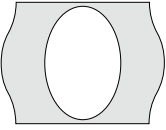
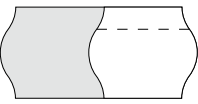
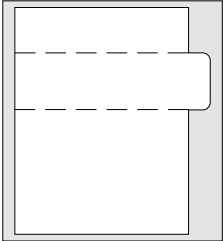
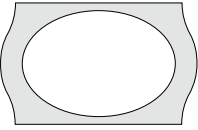
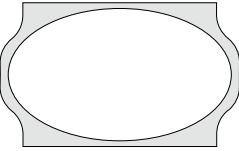
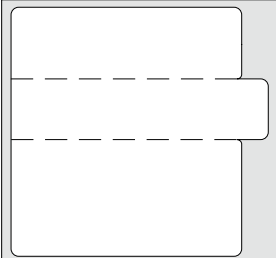
	18 x 11 mm		26 x 27 mm octagon I
	19 x 12 mm		
	22 x 16 mm		26 x 27 mm octagon II
	32 x 20 mm (thermo)		
	32 x 28 mm (thermo)		26 x 26 mm screen
			25.5 x 25.5 mm triangle
	16 x 10 mm oval		
	19 x 12 mm rhombus		26.5 x 25.7 mm adhesive-free zone
	10 x 16 mm oval		
	14,3 x 12 mm		28.5 x 30 mm adhesive-free zone
	20 x 14 mm oval		
	29.5 x 17.5 mm oval		34 x 34.9 mm adhesive-free zone

SPECIAL LABEL FORMATS

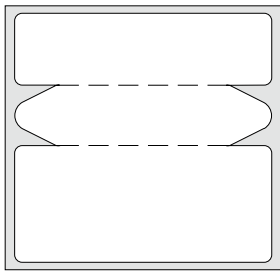

**34 x 34,9 mm
adhesive-free zone**

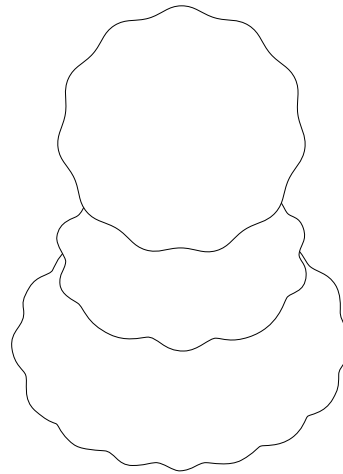

33 mm cloud

**33 x 25 mm
cloud**

**45 x 34 mm
cloud**

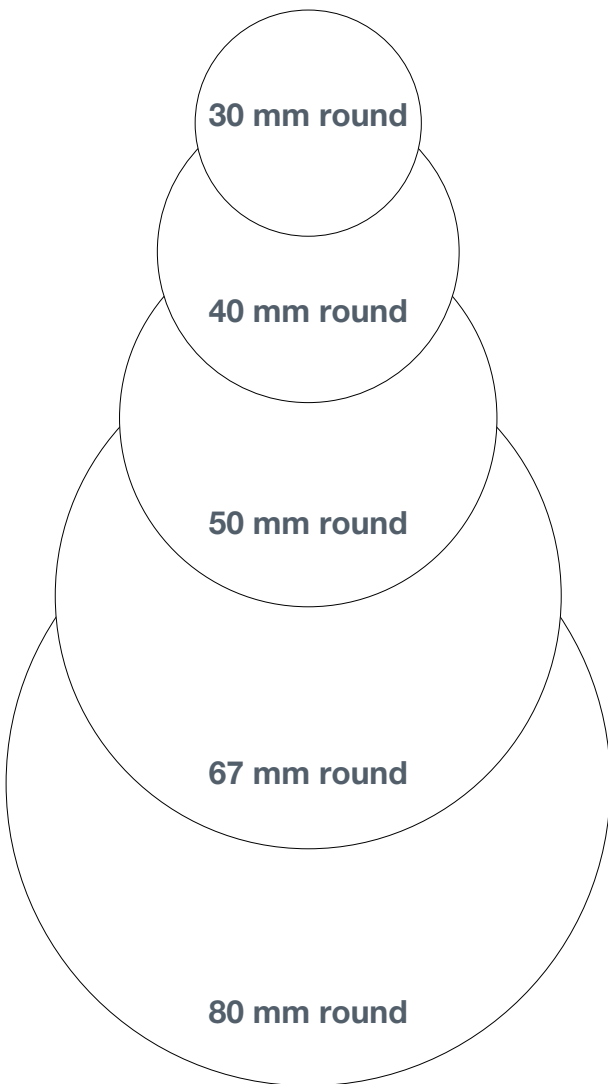

30 mm round

40 mm round

50 mm round

67 mm round

80 mm round



15 x 45 mm rectangular



45 x 15 mm rectangular



**58 x 50 mm
rectangular**

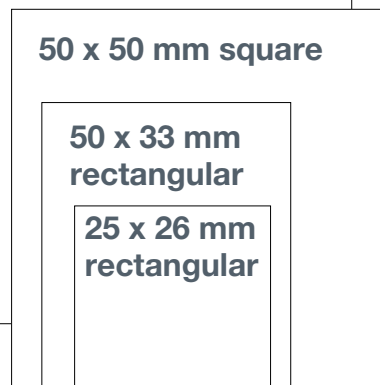

50 x 50 mm square

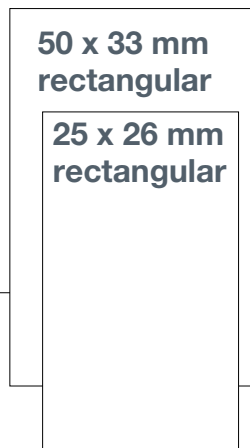

**50 x 33 mm
rectangular**

**25 x 26 mm
rectangular**



**36 x 66 mm
arrow**

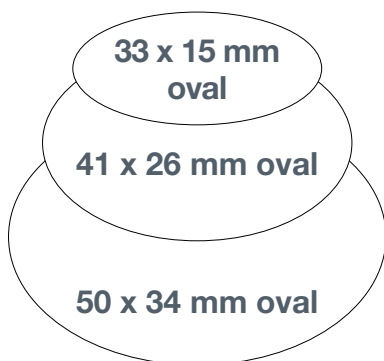

**33 x 15 mm
oval**

41 x 26 mm oval

50 x 34 mm oval



**81 x 30 mm
triangle**

LABEL COLORS

STANDARD LABEL AND PRE-PRINT COLORS

Preprint colors on white background



Preprint colors on fluorescent background

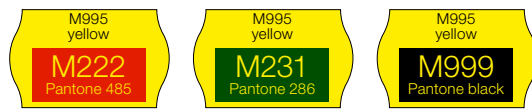

Preprint colors may appear visually different on other label background colors.

Label background colors

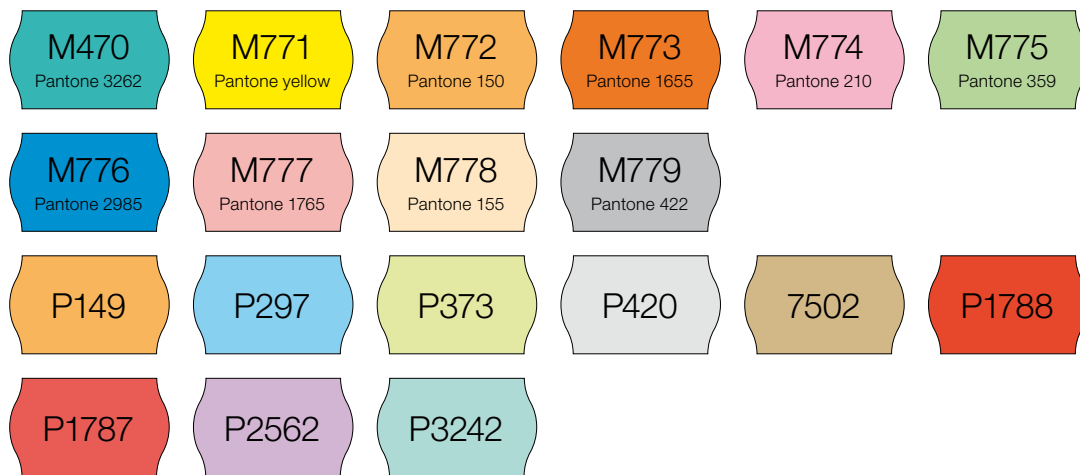

Label background colors, fluorescent



In addition to the here shown standard colors, we also realise your special company color according to the Pantone color guide.

The print colors shown here are not binding.

Please refer to our METO color chart for the original label and pre-print colors.

ADHESIVES

Adhesive 1	Removable, partly gummed
Adhesive 1.1	Removable, fully gummed
Adhesive 2	Permanent Standard
Adhesive 22	Permanent Steri, special gum for sterilisation labels
Adhesive 3	Permanent Soft, textile application (for light fabrics and lining materials)
Adhesive 4	Permanent Plus, stronger adhesive effect than Adhesive 2
Adhesive 5	Permanent Cool, for cooling and deep-freeze applications
Adhesive 6, 6.5	Permanent Special, water-removable
Adhesive 8	Permanent Super, water-resistant, weather-proof, strong adhesive effect (for plastic labels)
Adhesive 9	Permanent Food, for direct contact with slightly greasy foods (paper label)
Adhesive 9.1	Permanent Food, for direct contact with slightly greasy or waxed foods (plastic label, PP)
Adhesive 10	Permanent Dissolving (label and adhesive dissolve completely in water)
Adhesive 11	Permanent / removable, strong adhesive effect (only for PE, PP labels)

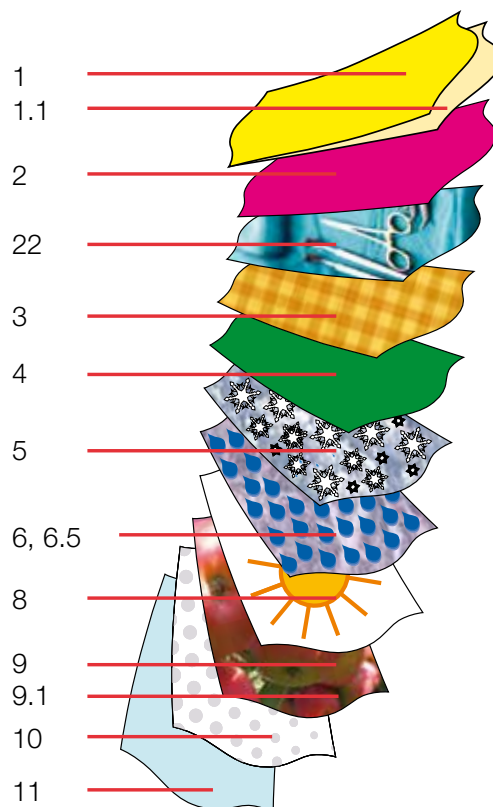

CUTS / PERFORATIONS

CUTS / PERFORATIONS

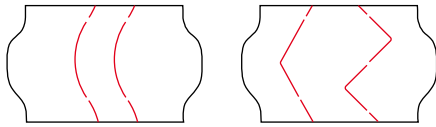

Security cut

Zig-zag security cut

Security cuts

Security cuts protects pre-labelling by customers. The security cut destroys the label.

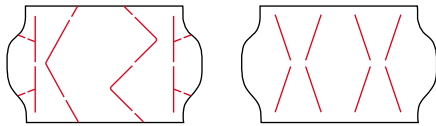

SuperSafe

V-cut

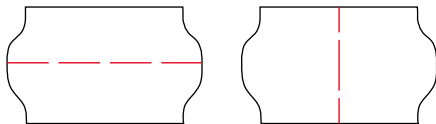

Horizontal perforation

Vertical perforation

Perforations

Perforations are important in combination with partly gummed labels, where one part has to be removed.

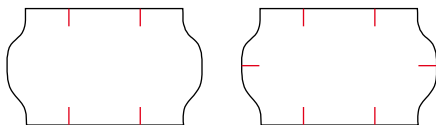

4-relax cut

6-relax cut

Relax cuts

Relax cuts guarantees the optimum on adhesion on curved surfaces.

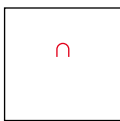

Cartex-cut

Cartex-cut

This cut allows the shooting of Cartex hang tags (coated plastic labels without adhesive) using swifttags.



CUSTOMER FLOW MANAGEMENT

TURN-O-MATIC CLASSIC & ACCESSORIES

Customers remember good service

Have you ever wondered why customers return to the same places, even though they may offer the same products at a higher price?

The answer is Customer Service!

Using TURN-O-MATIC® means that customers will be served in the right order but can walk around while they are waiting.

When customers are taking a number from a queuing system they feel more fairly treated and they get the feeling that service is more efficient. Giving them the freedom to move makes them feel less stressed and at the same time they tend to buy more.

TURN-O-MATIC is not only an advantage to your customers. Your staff as well will benefit from the investment. Stress is reduced, work better as a team, Customer contact is more positive and customers are more civilised.

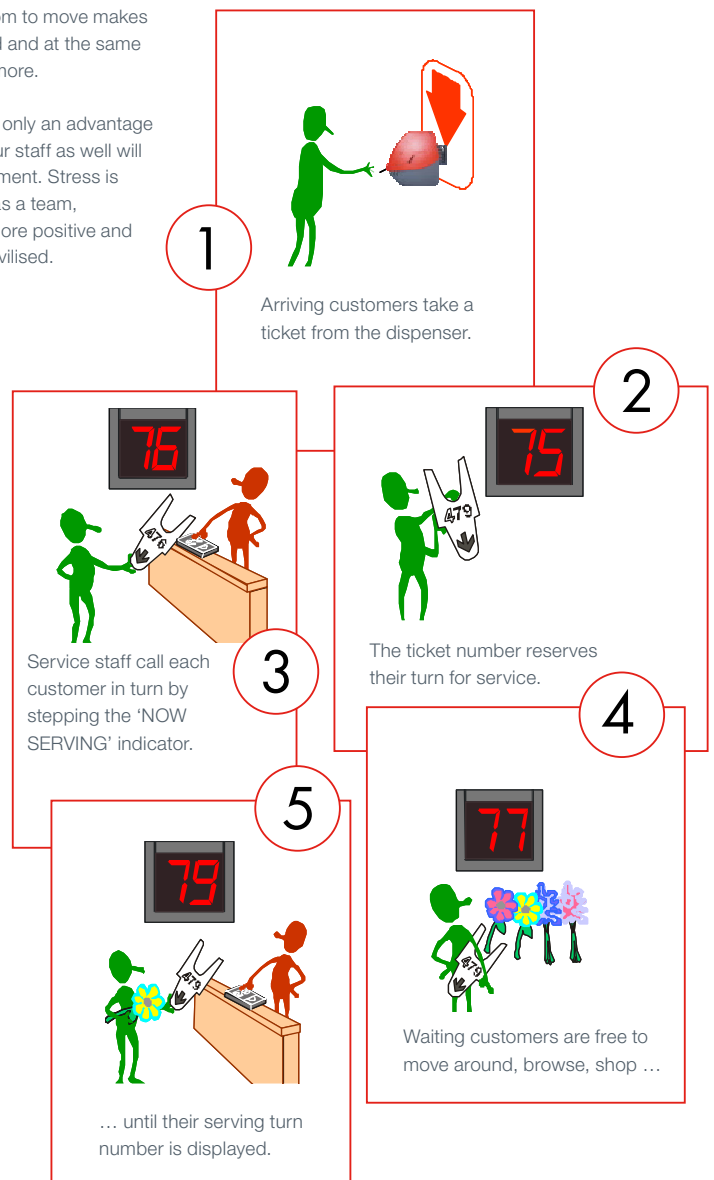

TURN-O-MATIC CLASSIC & ACCESSORIES



START pack S32 RF

Indicator with wireless receiver, 2-digit red LED display with housing colour black or red.

Dispenser with top cover colour in red, blue or grey.

Tickets, 6 rolls x 4000 tickets per roll with paper colour (T).

Plug-in power supply of type (A).

2 x wireless push button (+ and -).

Mounting equipment for dispenser and footstand.

Power supply cable length = 5 m (16 ½ ft).

■ Art. no.: 3832 CDTA

Quantity per unit: 1



START pack S33 RF

Indicator with wireless receiver, 3-digit red LED display with housing colour black or red.

Dispenser with top cover colour in red, blue or grey.

Tickets, 6 rolls x 4000 tickets per roll with paper colour (T).

Plug-in power supply of type (A).

2 x wireless push button (+ and -).

Mounting equipment for dispenser and footstand.

Power supply cable length = 5 m (16 ½ ft).

■ Art. no.: 3873 CDTA

Quantity per unit: 1

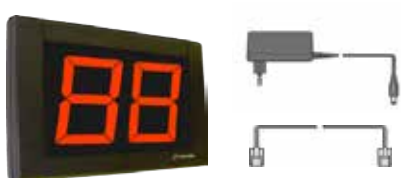

PLUS pack INR902 X1

Indicator, 2-digit red LED display with housing colour black or red.

Plug-in power supply of type (A).

Plug-in data cable, 25 m (82 ft).

Plug-in power extension cable.

Power supply cable length = 5 m (16 ½ ft).

■ Art. no.: 3852 C20A

Quantity per unit: 1



PLUS pack INR903 X1

Indicator, 3-digit red LED display with housing colour black or red.

Plug-in power supply of type (A).

Plug-in data cable, 25 m (82 ft).

Plug-in power extension cable (5 m).

Power supply cable length = 5 m (16 ½ ft).

■ Art. no.: 3852 C30A

Quantity per unit: 1

Article number options:

C) Display housing	3 = red 8 = black
D) Dispenser top cover	3 = red, 5 = blue, 9 = grey
T) Ticket color	1 = green, 3 = pink, 5 = blue, 6 = yellow, 7 = white
A) Power supply adaptor	0 = Europe 1 = Australia/New Zealand 2 = Canada/USA/Mexico 3 = UK 4 = Japan

TURN-O-MATIC CLASSIC & ACCESSORIES

TURN-O-MATIC CLASSIC ACCESSORIES



Wireless push button RFv2

Wireless push button on key chain.
Adhesive backed Velcro strip set for optionally fixing push button.
Max. 15 wireless push buttons per S3 RF system. Wireless push button codes must be copied into the RF receiver on the MASTER indicator.

■ Art. no.: 3809 0250

Quantity per unit: 1



PLUS pack K900 EU

4-digit red LED segment display. Digits 12 mm wide x 20 mm high.
Size (w x h x d), 106 x 70 x 170 mm. Housing material ABS.
Keypad material silicon rubber.
Non-skid rubber pads, mechanically fixed (not glued).
Plug-in power supply of type (A).
Plug-in data cable, 25 m (82 ft).

■ Art. no.: 3857 0010

Quantity per unit: 1

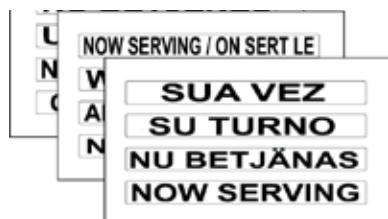

Text decal set IN90x, white text

Sticky text for extra instruction to the customer.

■ Art. no.: 3800 0040

Quantity per unit: 1



Dispenser D900

Dispenser for T90 tickets. Size (w x h x d), 88 x 250 x 280 mm.
Material – ABS, POM. Bottom housing in dark grey with colour choice for top cover colour in red, blue or grey.
Includes mounting screws and plugs.

■ Art. no.: 3950 90D0

Quantity per unit: 1

Article number options:

C) Display housing	3 = red 8 = black
D) Dispenser top cover	3 = red, 5 = blue, 9 = grey
T) Ticket color	1 = green, 3 = pink, 5 = blue, 6 = yellow, 7 = white
A) Power supply adaptor	0 = Europe 1 = Australia/New Zealand 2 = Canada/USA/Mexico 3 = UK 4 = Japan

TURN-O-MATIC CLASSIC & ACCESSORIES



Floor stand FS902, foot pack Telescope pack, sign holder

Foot with floor pads, 485 mm diameter, steel with silver grey metallic enamel finish.

Sign holder, A3 aluminium snap frame.

Holder for dispenser including the telescope collar to adjust the height, collar with 30 and 49 mm diameter at a length of 125 mm.

Outer telescope tube, 35 mm diameter x 1140 mm long, steel with silver grey enamel finish.

Inner telescope tube, 30 mm diameter x 1150 long, steel with silver grey enamel finish.

Includes hardware and tools for assembling floor stand.

■ Art. no.: 39588502

Quantity per unit: 1



Sign for floor stand

DIN A3 aluminum snap frame with comment sign and mounting hardware.

■ Art. no.: 9484724

Quantity per unit: 1



Aluminum counter stand with sign DIN A4

Aluminum counter stand with sign DIN A4 with metal baseplate and tape on bottom.

Silver aluminum.

Plastic parts light grey RAL 7035.

Adjustable in different positions.

Incl. frame and sign.

■ Art. no.: 9495686

Quantity per unit: 1



Ceiling Bracket CB902

Steel with silver grey enamel finish.

Includes tools and hardware for mounting 2 indicators (2 or 3 digit).

Includes expander plugs and bolts for ceiling mounting.

(Mounted length 640 – 1000 mm, adjustable in 105 mm increments).

■ Art. no.: 39490300

Quantity per unit: 1

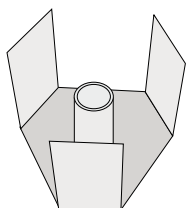

Mounting set, 3 x indicators

Steel with silver grey enamel finish.

Includes tools and hardware for mounting 3 indicators (2 or 3 digit).

(For mounting 3 indicators on ceiling bracket CB902 or at the top of the floor stand FS902).

■ Art. no.: 39491200

Quantity per unit: 1

TURN-O-MATIC CLASSIC & ACCESSORIES



Wireless push button set RFv2 replaces the old wire system

Indicator RF mounting bracket (deeper bracket for additional space behind indicator for wireless receiver).

Plug-in wireless receiver for indicator.

Wireless RFv2 push button with velcro strip.

Provides wireless push button upgrade for Indicator.

■ Art. no.: 3809 0241

Quantity per unit: 1



Bracket, dispenser D900

Bracket for the dispenser with holes to screw on the telescope collar.

■ Art. no.: 3800 9080

Quantity per unit: 1



Bracket, indicator standard

Bracket for the indicator without receiver.

■ Art. no.: 3959 1800

Quantity per unit: 1

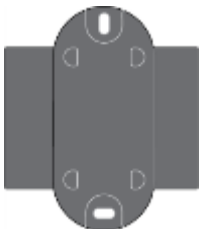

Bracket, indicator RF

Bracket for the indicator with receiver.

■ Art. no.: 3959 1800

Quantity per unit: 1



Power supply extension cable (3.2 m/10.5 feet)

Plug-in extension for Art. no. 3800 5000 power supply to give a total output cable length of 5 m (16.5 feet).

■ Art. no.: 3959 1800

Quantity per unit: 1



Twisted-pair shielded 26 AWG cable with RJ10 plugs

Cable to connect the K900 keypad to the indicator.

Cable to connect two indicators.

■ Art. no.: 3809 3310 data cable (0.5 m)

■ Art. no.: 3809 3330 data cable (5 m)

■ Art. no.: 3809 3370 data cable (25 m)

■ Art. no.: 3809 3390 data cable (50 m)

Quantity per unit: 1

TURN-O-MATIC CLASSIC & ACCESSORIES



Plug-in power extension cable

Cable to connect (power-connection) two indicators with one power supply.

- Art. no.: 38093411 (0.5 m)
- Art. no.: 38093461 (5 m)

Quantity per unit: 1



Power supply 24W 15VDC EU-US-UK-AU plug

Plug-in AC/DC switching adapter; 100-240VAC input, 15VDC output.
1.8 meter (6 feet) output cable with 2.5 mm DC plug.
Changeable AC plugs for EU-US-UK-AU outlets.
New higher efficiency EuP power supply required by EU Directive 2005-32-EC.

- Art. no.: 3800 5000

Quantity per unit: 1

Set power supply 24W 15VDC EU-US-UK-AU plug

Plug-in AC/DC switching adapter; 100-240VAC input, 15VDC output.
1.8 meter (6 feet) output cable with 2.5 mm DC plug.
Changeable AC plugs for EU-US-UK-AU outlets.
New higher efficiency EuP power supply required by EU Directive 2005-32-EC.
Extension power supply (3.2 m).

- Art. no.: 38093900

Quantity per unit: 1

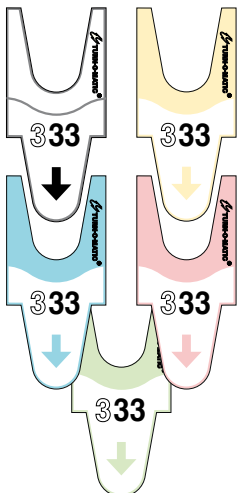

Tickets T90 3D 24K standard

Carton of 6 rolls x 4000 tickets per roll. Ticket size, 31 wide x 67 mm long.
Black print on ticket paper colour (T). 3-digit black sequential numbering 000 – 999 four times, first digit in outline print. D900A3 sensor marking on back.

- Art. no.: 39649170 white
- Art. no.: 39649160 yellow
- Art. no.: 39649150 blue
- Art. no.: 39649130 pink
- Art. no.: 39649110 green

Ticket size: 31 wide x 67 mm long

Quantity per unit: 1 (carton of 6 rolls, 4,000 tickets per roll)

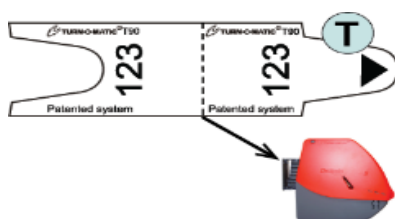

Tickets T90 DBL 12K standard

Carton of 6 rolls x 2000 tickets per roll. Ticket size 31 wide x 107 mm long.
Black print on white ticket paper. Double 3-digit black sequential numbering 000 – 999 two times. Perforated for two-part separation.
D900A3 sensor marking on back.

- Art. no.: 39649271 white

Ticket size: 31 x 107 mm

Quantity per unit: 1 (carton of 6 rolls, 2,000 tickets per roll)

Tickets for system Turn-O-Matic T80 on request (on stock).

TOM TOUCH+ & ACCESSORIES

TOM TOUCH+ & ACCESSORIES



TOM touch+ (EU/UK)

Including 7-inch LCD/touch screen, electronic ticket unit. 3-positions red dot-matrix display, intelligent terminal, wall mounting both for display and main LCD unit, 15 m, 7 m, 2 m black modular cable, connector, one ticket roll contain 2,000 tickets, quick start, quick guide and user manual.

■ Art. no.: 9479075

Quantity per unit: 1



TOM touch+ display ID2, ID3

Including 7 m cable.

■ Art. no.: 9479077 (ID2)

■ Art. no.: 9479078 (ID3)

Quantity per unit: 1



TOM touch+ terminal ID2, ID3

Including 7 m and 2 m cables.

■ Art. no.: 9479079

■ Art. no.: 9479100

Quantity per unit: 1



TOM touch+ main display

Including 15 m cable.

■ Art. no.: 9479101

Quantity per unit: 1



TOM touch+ satellite box (EU/UK)

Including 7 m cable and power supply.

■ Art. no.: 9479102

Quantity per unit: 1

TOM TOUCH+ & ACCESSORIES



TOM touch+ floor stand

■ Art. no.: 9469115

Quantity per unit: 1



TOM touch+ weight for floor stand

■ Art. no.: 9469116

Quantity per unit: 1

TOM touch+ column upper, 1,100 mm

■ Art. no.: 9469117

Quantity per unit: 1

TOM touch+ extension bracket upper column

■ Art. no.: 9469118

Quantity per unit: 1

TOM touch+ signboard for floor stand

■ Art. no.: 9469119

Quantity per unit: 1



TOM touch+ display clamp

■ Art. no.: 9469120

Quantity per unit: 10



TOM touch+ table stand

■ Art. no.: 9469121

Quantity per unit: 10



TOM touch+ ticket roll

■ Art. no.: 9469122

Quantity per unit: 10 rolls per 2,000 tickets



HAPPYORNOT

HappyOrNot – Customer Satisfaction Analysis

A specific question for the customer, four self-explanatory smiley buttons for spontaneous replies, a wireless device at the desired spot and all the results swiftly evaluated – the simple way to measure customer satisfaction! HappyOrNot is a mobile service device to promote lasting customer loyalty which can be deployed wherever customers come into contact with a product, an offer, a service or a new item. Asking customers a readily comprehensive question here and offering them a straightforward, anonymous means of responding directly yields important information on buying behaviour. A crucial aspect is the fact that HappyOrNot evaluates these data on a daily basis and transmits the results to the client at a defined time, enabling swift action to be taken as necessary. This provides chain store companies in particular with an effective means of avoiding declines in sales, losses of customers, uncertainty or dissatisfaction while offering an ideal instrument to support change processes or market launches. At the same time, customers feel that they are being taken seriously and that their custom and opinions are appreciated. This establishes closer ties with customers and improves customer satisfaction, leading in the long term to stable or improved sales.



Who benefits from HappyOrNot?

HappyOrNot is suitable for all areas of business in which it is important to know customers' opinions. As an ideal customer barometer, it remains in direct contact with customers throughout the opening hours of chain stores, retail outlets, service companies or catering establishments, its wireless design enabling it to be deployed wherever appropriate. There's no faster way of gathering and evaluating customers' views.



Technical data

- Console color: cream white; stand with base: aluminium grey
- Dimensions incl. question display: 144 x 47 x 20 cm (H/W/D)
Total weight: 14.0 kg
- Display for DIN A3 landscape format included; questions simple to formulate with PC
- Internal energy source for mobile use (D-cell batteries, running time approx. 2 years) and wireless data transfer method
- Automatic daily reporting service for collected data, web-based or by e-mail
- Individualised analyses and reports according to task area and management levels
- GSM Frequency Band: Quadband 850/900/1800/1900 MHz

How it works

- The devices are installed at the desired service points
- The customer answers the questions voluntarily, anonymously and spontaneously
- Data transfer and evaluation take place on a daily basis
- Corresponding daily reports are supplied to the client by e-mail or online

HAPPYORNOT



Advantages

- Simple and clearly comprehensible operation
- Company-wide data collection for enhanced service quality
- Improved customer satisfaction and customer loyalty
- Increased staff motivation
- Strengthened market position and higher revenue possible
- Improved image

How satisfied are customers with the availability of products ?

- 😊 Whatever segment HappyOrNot may be deployed in, product availability is always an important matter from the customer's point of view. And only satisfied customers will return.

How competent and efficient is the service ?

- 😊 Quickly uncover possible failings in service quality – a key factor when it comes to customer satisfaction. HappyOrNot reveals precisely where and when improvements are required – whatever your field of business.

Is the new product a hit ?

- 😊 HappyOrNot measures the acceptance of all types of products – from apples to automobiles. Whatever new items the client introduces, HappyOrNot provides for well-aimed and professional market implementation.

- Art. no.: on request

Quantity per unit: 1

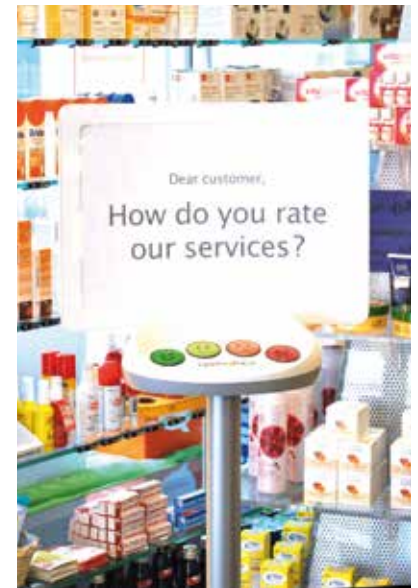

METO[®]
Powered by **HAPPYORNOT**



METO[®]



FASTENER

FASTENER & ACCESSORIES



The color of the V-tool may differ to the image shown here.

V-Tool

Automatically connect a single loop fastener in a fraction of the time it takes to fasten by hand without perforating products. Each tool is comfortable, lightweight, and designed to be durable and reliable. Attach tags securely

- Does not use needles
- Lightweight and compact
- Quick and cost effective
- Ergonomic and safe

■ Art. no.: 9201137 V-Tool

Quantity per unit: 1

■ Art. no.: 9201164 Fastening Pin 102 mm, white

Quantity per unit: 5,000

■ Art. no.: 9201166 Fastening Pin 127 mm, white

Quantity per unit: 5,000



Fastener Heavy

Fastening tool specifically developed to meet special tagging requirements of the horticultural industry. Garden tool perforates rubber and plastic pottery seamlessly. Durable and reliable.

■ Art. no.: 9170783 Fastener Heavy

Quantity per unit: 1

■ Art. no.: 9121828 Needle steel

Quantity per unit: 5

■ Art. no.: 9121372 Swifttach 13 mm standard, 100 clip

■ Art. no.: 9121374 Swifttach 25 mm standard, 100 clip

■ Art. no.: 9121375 Swifttach 50 mm standard, 100 clip

■ Art. no.: 9121376 Swifttach 75 mm standard, 100 clip

Quantity per unit: 10,000

■ Art. no.: 8006980 Swifttach 125 mm standard, 100 clip

Quantity per unit: 5,000



FASTENER & ACCESSORIES



Fastener Standard

Fastening tool for standard textile applications. Ideal for tagging low volumes of goods.

■ Art. no.: 9121348 Fastener standard

Quantity per unit: 1

■ Art. no.: 9121826 Needle standard steel with plastic base

Quantity per unit: 5

■ Art. no.: 9121372 Swifttach 13 mm standard, 100 clip

■ Art. no.: 9121374 Swifttach 25 mm standard, 100 clip

■ Art. no.: 9121375 Swifttach 50 mm standard, 100 clip

■ Art. no.: 9121376 Swifttach 75 mm standard, 100 clip

Quantity per unit: 10,000

■ Art. no.: 8006980 Swifttach 125 mm standard, 100 clip

Quantity per unit: 5,000



Display Hook

Displayhooks are attached to products just as easily as regular paddle swifttags. They allow to present items like socks or hats in hang-view display.

■ Art. no.: 9121348 Display hook 35 mm, white

Quantity per unit: 5,000



Fastener Fine

Fastening tool with extra fine needle for fine textile applications. Brandless. Ideal for tagging low volumes of goods.

■ Art. no.: 9197971 Fastener fine basic

Quantity per unit: 1

■ Art. no.: 9121827 Needle fine with plastic base

Quantity per unit: 5

■ Art. no.: 9121350 Swifttach 15 mm fine, white

■ Art. no.: 9121308 Swifttach 20 mm fine, white

■ Art. no.: 9121309 Swifttach 40 mm fine, white

Quantity per unit: 10,000

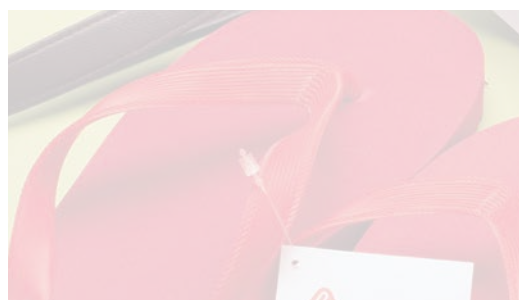



METO MERCHANDISING SOLUTIONS – PRICE ADJUSTMENTS AND SPONTANEOUS PROMOTIONS THE EASY WAY

The shopping environment is crucial to successful selling. Do you offer your customers a congenial atmosphere? Are they able to find what they need quickly? Is their attention drawn to product offerings which might interest them? Customers want clear guidance in an appealing environment: The shopping experience is a key factor that either helps or hurts a store.

Our store-level communication products offer comprehensive solutions to help you design your sales premises in a manner conducive to boosting your profits. We offer solutions for making profitable your sales area while meeting legal labeling requirements (FIR).



PRICE CASSETTES/PRICE DISPLAYS

PROMOSIGN CASSETTE FRUIT & VEGETABLES



PromoSign cassettes fruit & vegetables 160 x 38 DB

Art. no.:	Body / slider	Leporello set
8327000	white RAL 9016 / transparent	PVC, green text
8327001	black RAL 9005 / transparent	PVC, black negative, chalk-look
8327003	green RAL 6024 / transparent	PVC, black negative, chalk-look



Quantity per unit: 25



Text range fruit & vegetables

Photo: German-language version.
Application: For PromoSign cassettes 160 x 84 mm.

Art. no.:	Text
9011555	green
9011556	black negative, chalk-look



Format: 117 x 38 mm
Material: PVC

Quantity per unit: 1



Self-service number range for PromoSign cassettes fruit & vegetables

Photo: German-language version.
Application: For PromoSign cassettes 160 x 84 mm.



Art. no.:	Version	Numbers from ... to
8327409	white text, with yellow numbers, chalk-look	1 ... 99
9409058	white text, with yellow numbers, chalk-look	100 ... 199

Material: PVC

Quantity per unit: 1



Price frame

Application: Alternative to price cassette, open version.
Pocket inserts see p. 92.

Art. no.: 9217681

Format: Outer: 154 x 75 mm · Inner: 150 x 70 mm
Material: ABS
Color: Black RAL 9005



Quantity per unit: 50

ACCESSORIES FRUIT & VEGETABLES



PromoSign fixing hook

Application: Adaptor for clicking into the back of all PromoSign cassettes, with open eyelet.

Art. no.:	Version
9005067	one-sided, two adaptors needed per cassette
9005068	double-sided, two adaptors needed per two cassettes

Material: Polycarbonate
Color: Transparent

Quantity per unit: 20

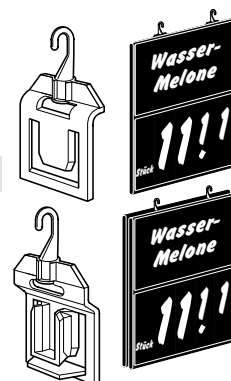

Price rail adaptor, variable

Application: Fixing device for PromoSign cassettes, for attachment to price rails 8335211 / 9136702.

Art. no.: 8329801

Material: POM
Color: White / black

Quantity per unit: 50

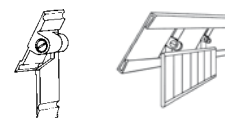

Price rail adaptor, fixed

Application: Fixing device for PromoSign cassettes, for attachment to price rails 8335211 / 9136702.

Art. no.: 8329804

Material: POM
Color: White

Quantity per unit: 50

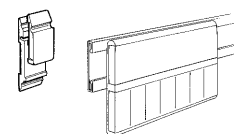

Security hooks

Application: Fixing device for PromoSign cassettes, for attachment to wire baskets, tubes or similar.

Art. no.:	Diameter	Color
8329802	12 mm	white
8329803	16 mm	white
9211569	12 mm	black
8372524	16 mm	black

Material: POM

Quantity per unit: 50

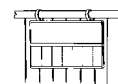

PROMOSIGN CASSETTES & ACCESSORIES



Fruit & vegetables box clamp with swing mount

Application: Clamp for universal fixing of all types of PromoSign cassettes to boxes and trays (wood / plastic). Can be set at two different heights.

■ Art. no.: 8327233

Material: ABS
Color: Black RAL 9005

Quantity per unit: 10

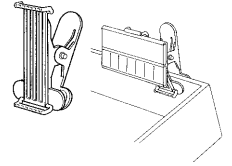

Closed PromoSign holding rail

Application: For protecting PromoSign cassettes (160 x 84 mm) against dirt, dust etc. Front is transparent (front folds upward) with adhesive strip on the back.

■ Art. no.:	Length	Color	Quantity per unit
9200363	100 cm	white RAL 9016 / transparent <input type="checkbox"/>	5
8327341	124 cm	white RAL 9016 / transparent <input type="checkbox"/>	1
8327342	100 cm	green RAL 6024 / transparent <input checked="" type="checkbox"/>	1
8327343	124 cm	green RAL 6024 / transparent <input checked="" type="checkbox"/>	1
9134309	100 cm	black / transparent <input checked="" type="checkbox"/>	1
9134310	124 cm	black / transparent <input checked="" type="checkbox"/>	1
9407084	100 cm	grey RAL 9007 / transparent <input checked="" type="checkbox"/>	1
9407085	124 cm	grey RAL 9007 / transparent <input checked="" type="checkbox"/>	1

Material: ABS
Other colors on request

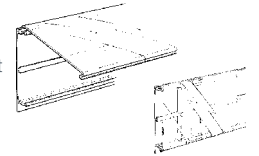

Open holding rail 40 x 1,000 mm

Application: Price rail for holding all types of PromoSign cassettes with price rail adaptors 8329801 / 8329804.

■ Art. no.:	Color	Quantity per unit
8335211	black RAL 9005 <input checked="" type="checkbox"/>	1
9136702	green RAL 6024 <input checked="" type="checkbox"/>	10

Material: PVC

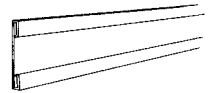

Perforated carton labels for PromoSign / PromoLabel see the chapter Creative Display Solutions (p. 93).

Create goods texts quickly and easily with the METO price tag editor (www.meto-pricetageditor.com).

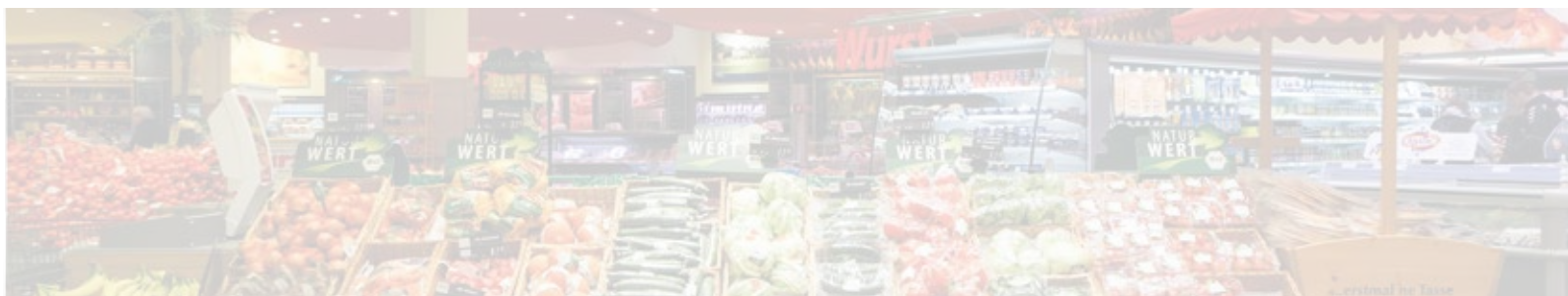

PROMOSIGN CASSETTES & ACCESSORIES



Clamp adaptor for signs

Application: Clamp for attaching laminated or film-covered price tickets to boxes and trays (wood / plastic). Flexible adjustment via grid.

■ Art. no.: 9217857

Width: 50 mm
Material: PC, crystal-clear
Color: Transparent

Quantity per unit: 25



Grass mat for fruit & vegetables departments

■ Art. no.: Size

8311995	92 x 100 cm
8311997	92 x 2500 cm roll

Quantity per unit: 1

PROMOSIGN CASSETTES SERVICE COUNTER



PromoSign display A3 for counter area

Photo: German-language version. Any language available on request.
Application: PromoSign display for special-offer labeling in the counter rear wall area. With text slider, format DIN A4 and leporello slider, five-piece "special offer" set.

■ Art. no.: 9005950

Format: 305 x 445 mm
Material: Body: ABS · slider: SAN / PVC
Color: Black RAL 9005
Leporello set: PVC, black negative, chalk-look

Quantity per unit: 5



PromoSign cassettes meat & sausage

Photo: German-language version.

■ Art. no.:	Format	Color		Text
8327020	74 x 55 mm	white RAL 9016		black positive
8327027	74 x 55 mm	red RAL 3000		black negative, chalk-look
8327022	74 x 55 mm	black RAL 9016		black positive
8327029	74 x 55 mm	red RAL 3000		black negative, chalk-look

Format: 74 x 55 mm
Material: Body: ABS · slider: SAN / PVC
Leporello set: PVC

Quantity per unit: 25



PROMOSIGN CASSETTES & ACCESSORIES



PromoSign cassettes poultry

Photo: German-language version.

Art. no.:	Format	Color		Text
8327084	74 x 55 mm	white RAL 9016	<input type="checkbox"/>	black positiv
9489493	74 x 55 mm	black RAL 9005	<input checked="" type="checkbox"/>	black negativ

Format: 74 x 55 mm
Material: Body: ABS · slider: SAN / PVC
Leporello set: PVC

Quantity per unit: 25



PromoSign extension cassette expiry date

Extension cassette to set expiry date of fresh goods.

Photo: German-language version.

Art. no.:	Format	Color		Text
9489494	74 x 24 mm	white RAL 9016	<input type="checkbox"/>	black positiv
9489495	74 x 24 mm	black RAL 9005	<input checked="" type="checkbox"/>	black negativ

Format: 74 x 24 mm
Material: Body: ABS · slider: SAN / PVC
Leporello set: PVC

Quantity per unit: 25



PromoSign cassettes cheese

Photo: German-language version.

Art. no.:	Format	Color		Text
8327030	74 x 55 mm	white RAL 9016	<input type="checkbox"/>	black positiv
8327032	74 x 55 mm	yellow RAL 1021	<input checked="" type="checkbox"/>	black positiv
8327031	74 x 55 mm	black RAL 9005	<input checked="" type="checkbox"/>	black negative, chalk-look
8327034	74 x 55 mm	yellow RAL 1021	<input checked="" type="checkbox"/>	black negative, chalk-look

Material: Body: ABS · slider: SAN / PVC
Leporello set: PVC

Quantity per unit: 25

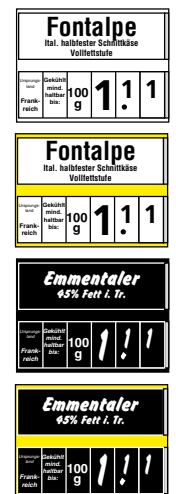

PromoSign cassettes fish & delicatessen

Photo: German-language version.

Art. no.:	Format	Color		Text
9114379	74 x 55 mm	blue RAL 5015	<input checked="" type="checkbox"/>	black negative, chalk-look
8327050	74 x 55 mm	white RAL 9016	<input type="checkbox"/>	black positiv

Format: 74 x 55 mm
Material: Body: ABS · slider: SAN / PVC
Leporello set: PVC

Quantity per unit: 25

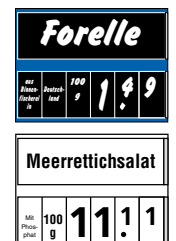

Perforated carton labels for PromoSign / PromoLabel see the chapter Creative Display Solutions (p. 93).

Create goods texts quickly and easily with the METO price tag editor (www.meto-pricetageditor.com).

PROMOSIGN CASSETTES & ACCESSORIES

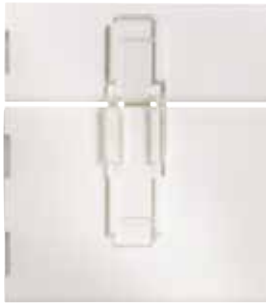

Two-way connector for PromoSign 07424 SB/DB

Application: For connecting PromoSign cassettes 74 x 55 mm with add-on cassettes, with an adaptor for an individual stand.

■ Art. no.: 8327223

Length: 50 mm
Material: Polycarbonate
Color: Transparent

Quantity per unit: 10

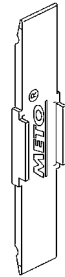

Closed PromoSign holding rail 74 DB

Application: For protecting PromoSign cassettes 74 x 55 mm against dirt, dust etc. Front is transparent (can be folded upwards).

■ Art. no.:	Length	Color	Quantity per unit
8329580	100 cm	white RAL 9016 / transparent <input type="checkbox"/>	1
9202038	124 cm	white RAL 9016 / transparent <input type="checkbox"/>	5
9418826	124 cm	alu.-grey RAL 9007 / transp. <input checked="" type="checkbox"/>	5

Other Colors on request.

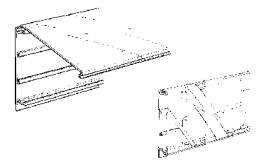

Text range poultry

Photo: German-language version.

Application: 105 text inserts for fresh poultry. Colors black/white ore white black.

■ Art. no.:	Color	Quantity per unit
9237392	white <input type="checkbox"/>	1
9489451	black <input checked="" type="checkbox"/>	1

Special offer sign range

Photo: German-language version.

Application: For attachment to the back of PromoSign cassettes in combination with the individual stands and PromoSign adaptor. 7 x 10 "special offer" signs for PromoSign cassettes 74 x 55 mm.

New additions: "lactose-free" and "gluten-free"

■ Art. no.: 8327400

Quantity per unit: 1

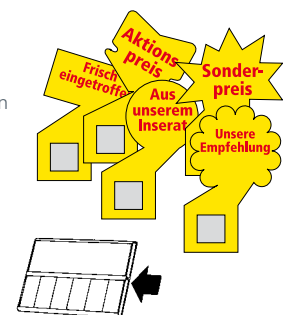

PromoSign crowner "best before"

Photo: German-language version.

Application: "Keep refrigerated – best before" crowner for PromoSign cassettes 74 x 55 mm. Complete with special marker pen, black.

For attachment to the back of PromoSign cassettes in combination with the individual stands and PromoSign adaptor.

■ Art. no.: 8327410

Quantity per unit: 1 assortment (contains 50 pieces)

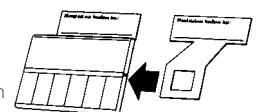

PROMOSIGN / PROMOLABEL CASSETTES & ACCESSORIES



PromoSign crowner Bio logo

Application: For PromoSign cassettes 74 x 55 mm. For connection to the back of PromoSign cassettes in combination with the individual stands and PromoSign adaptor. For marking of products in accordance with EU Regulation 271/2010 (organic production).

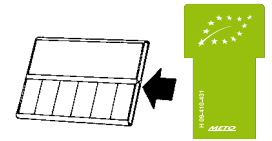

■ Art. no.: 9410431

Format: 45 x 30 mm
Material: PVC

Quantity per unit: 10



Bio logo insert

Application: Insert for PromoSign cassettes.

■ Art. no.: 9411010

Format: 38 x 38 mm
Material: PVC

Quantity per unit: 50



PROMOSIGN / PROMOLABEL BEVERAGE DEPARTMENT



PromoSign cassette beverages

Photo: German-language version.

Application: Cassette for price marking of beverages in smaller displays or on shelves. With display of net price and separate deposit prices per crate and per bottle, and an upper slider for text inserts in format 77.5 x 38 mm.

■ Art. no.: 8327080

Format: 160 x 84 mm
Material: Body: ABS · slider: SAN / PVC
Color: White RAL 9016
Leporello set: PVC, text black positive, grey negative

Quantity per unit: 10



Price rail adaptor for PromoSign 16038 SB / DB

Application: For the attachment of PromoSign cassettes 160 x 84 mm and 160 x 42 mm to scanning profiles without lip.

■ Art. no.: 8327222

Material: PVC
Color: Transparent

Quantity per unit: 10

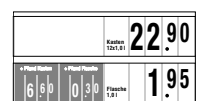

PROMOSIGN / PROMOLABEL CASSETTES & ACCESSORIES



PromoSign displays beverages

Photo: German-language version.

Application: PromoSign beverage price displays with PromoSign attachment holders on the back. Upper slider for text insert, format A5 landscape, with plastic clip to hold text insert against front of slider. For beverage price marking in beverage stores. With display of net price, unit price and separate deposit prices per crate and per bottle.

■ Art. no.: Color

8327705 white RAL 9016

8327709 yellow RAL 1021

Format: 217 x 331 mm

Material: Body: ABS · slider: SAN / PVC

Leporello set: PVC, text black positive, grey negative

Quantity per unit: 10

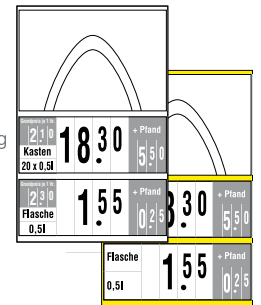

PromoLabel display beverages

Photo: German-language version.

Application: For beverage price marking in beverage stores. PromoLabel beverage price display with text insert, format DIN A5 landscape and two inserts for crate and bottle prices.

■ Art. no.: Color

9109514 yellow RAL 1021

Format: 330 x 220 mm

Material: Body: ABS · slider: SAN / PVC

Quantity per unit: 10



PromoSign add-on cassette

Application: For attachment below or above the PromoSign display for additional information, insert format 210 x 80 mm. Consisting of body and slider, with 20 two-way connector pieces (8329578).

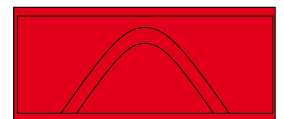

■ Art. no.: Color

8327712 red RAL 3000

Format: 217 x 88 mm

Material: Body: ABS · slider: SAN / PVC

Quantity per unit: 10



Special offer sign

Photo: German-language version. Application: For attachment underneath the PromoSign beverage display.

■ Art. no.: Text

8327762 Special offer, German version

Material: PVC, printed

Quantity per unit: 10

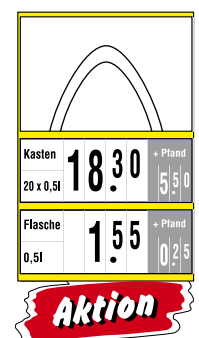

PROMOSIGN / PROMOLABEL CASSETTES & ACCESSORIES



PromoSign fixing hook

Application: Adaptor for clicking into the back of all PromoSign cassettes, with open eyelet.

Art. no.:	Version
9005067	one-sided, two adaptors needed per cassette
9005068	double-sided, two adaptors needed per two cassettes

Material: Polycarbonate
Color: Transparent

Quantity per unit: 20



Two-way connector, rigid

Application: For connecting two or more PromoSign cassettes one atop the other.

Art. no.: 8329578

Material: Polycarbonat
Color: Transparent

Quantity per unit: 20

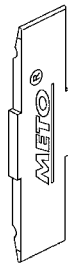

PromoSign hooks for suspension tubes

Application: Hooks for hanging displays from suspension tubes.

Art. no.: 8329577

Material: Polycarbonate
Color: Transparent

Quantity per unit: 20

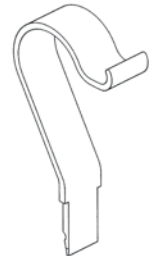

PROMOLABEL CASSETTES & ACCESSORIES

PROMOLABEL CASSETTES SERVICE COUNTER & SHELF



PromoLabel S



PromoLabel BSM



PromoLabel M



PromoLabelaqua

PromoLabel

Application: Cassettes for pricing goods on service counter and shelves.
Price cassette consists of: Body and slider for the display of labels.

Art. no.:	PromoLabel	Format	Color	Label size
9105311	S	74 x 55 mm	black RAL 9005	70 x 49 mm
9105312	S	74 x 55 mm	white RAL 9016	70 x 49 mm
9105315	S	74 x 55 mm	red RAL 3000	70 x 49 mm
9217155	BSM	120 x 82 mm	black RAL 9005	117 x 78 mm
9105316	M	164 x 85 mm	black RAL 9005	156 x 78 mm

Material: Body: ABS · slider: SAN

Quantity per unit: 25



PromoLabel S Premium sausage / cheese

- Art. no.: 9229024 (black RAL 9005)
- Art. no.: 9410738 (red RAL 3000)

Format: 74 x 55 mm

Material: Body: ABS · slider: SAN / PVC

Leporello set: PVC, text black

Quantity per unit: 25

PromoLabelaqua

Application: The price cassette system for fresh merchandise, with protection against splashed/sprayed water – for implementation of the provisions of the Food Information Regulation (FIR) in the retail sector.

- Art. no.: 9469930

Format: 95 x 66 mm (without decorative frame), text inserts DIN A8

Material: Styrolux

Color: Transparent

Quantity per unit: 25



Perforated carton labels for PromoSign / PromoLabel see the chapter Creative Display Solutions (p. 93).





Create goods texts quickly and easily with the METO price tag editor (www.meto-pricetageditor.com).

PROMOLABEL CASSETTES & ACCESSORIES



PromoLabelaqua decorative frames

Application: Decorative frames for identification of the merchandise group/ department can be clickfitted on the front.

Art. no.:	Color	
9472840	black	
9472841	yellow	
9472842	red	
9472843	blue	

Format: 98 x 69 mm

Material: ABS

Quantity per unit: 25

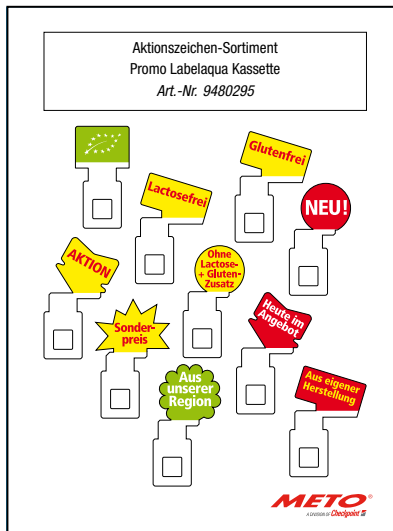

Special offer sign range PromolLabelaqua

Photo: German-language version.

Application: Special offer sign range for attachment to the back of PromoLabelaqua cassettes.

Art. no.: 9480295

Material: PVC

Quantity per unit: 10 signs per 10 pieces



PROMODISPLAY

The PromoDisplay system offers a smart and convenient price marking system for fresh produce, delicatessen and service counters. The modular design of the system ensures easy handling, allowing prices and texts to be changed quickly at any time.

The PromoDisplay system consists of mutually compatible modules, allowing it to be adapted and extended as required.

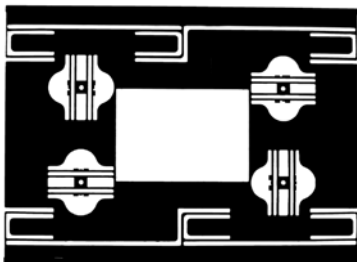
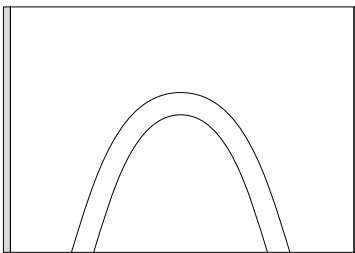
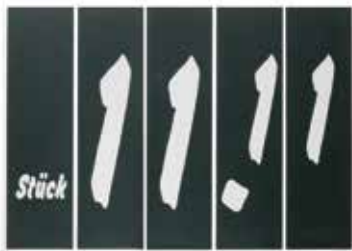

PromoDisplay slider, chalk-look

Photo: German-language version.

System consists of:

- 5 transparent sliders for text sheets in format DIN A4 landscape
- 5 leporello sliders with insert set

■ Art. no.: 9101207

Quantity per unit: 5/5



Transparent text slider

Application: For text inserts DIN A4 landscape.

■ Art. no.: 8003325

Format: 305 x 215 mm

Material: SAN / PVC

Quantity per unit: 1

PromoDisplay spring frames

Application: Spring frames for the attachment of PromoDisplay sliders.

■ Art. no.: 9101209

Format: 305 x 223 mm

Material: ABS

Color: Black RAL 9005

Quantity per unit: 10

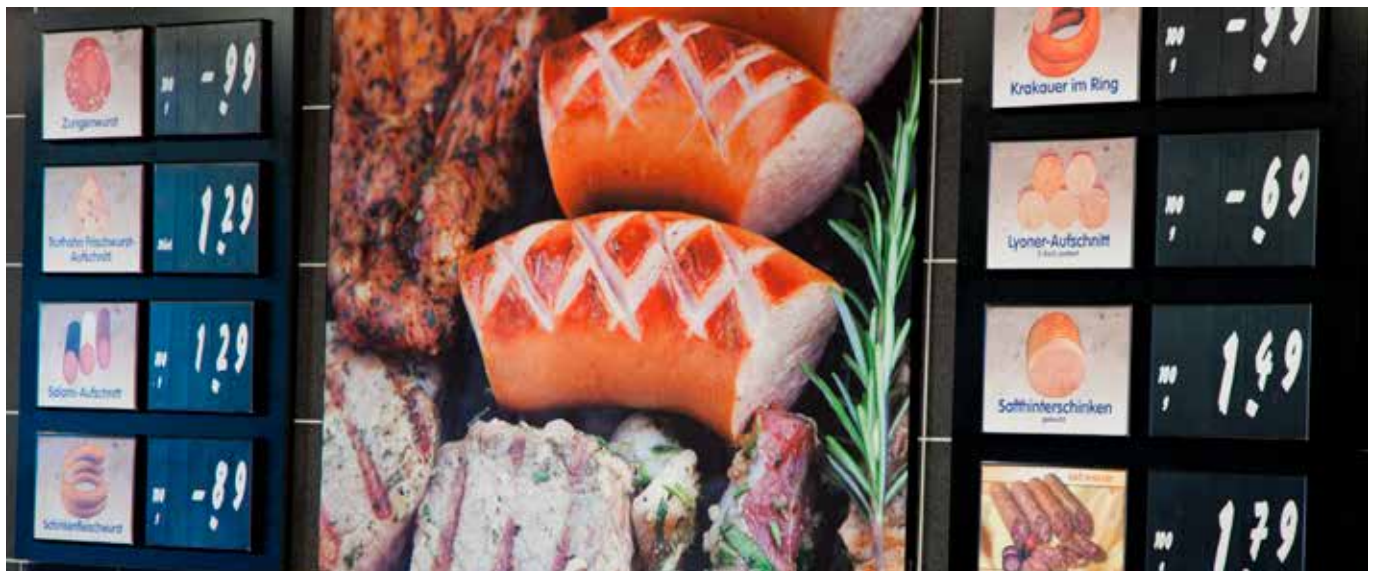

PROMOSIGN/PROMOLABEL ACCESSORIES

PROMOSIGN/PROMOLABEL ACCESSORIES

PromoSign/PromoLabel/PromoLabelaqua individual stands

Application: To be used in service counters (delicatessen, meat, cheese etc.).

■ Art. no.: Height till the lower edge of the cassette

8327200	5 cm
8327201	10 cm
8328007	15 cm

Material: PC
Color: Transparent

Quantity per unit: 25

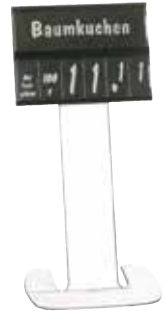

Individual stand with information text on the back

Application: For the insertion of sales information in the back of the stand.

■ Art. no. 8327210

Size: 47 x 63 mm / information text insert 40 x 60 mm

Material: PP
Color: Transparent

Quantity per unit: 25

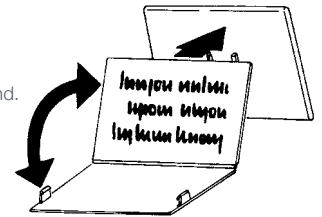

PromoSign/PromoLabel/PromoLabelaqua universal stand

Application: Transparent stand for holding price cassettes.

■ Art. no.: 9465799

Size: 70 x 54 mm / 98 x 54 mm

Material: Styrolux
Color: Transparent

Quantity per unit: 25



PromoSign/PromoLabel/PromoLabelaqua ice spit

Application: Semi-transparent accessory spit to fix cassettes in crushed ice (service counters).

■ Art. no.: 9470845

Length: 175 mm

Material: PC

Quantity per unit: 25

PROMOSIGN/PROMOLABEL ACCESSORIES



PromoSign/PromoLabel/PromoLabelaqua acrylic stands

Application: Acrylic stands, especially designed to place between meat trays with slated edges.

■ Art. no.: | Height

9483406 | 5 cm

9483407 | 8 cm

Material: Acrylic glass, 2 mm

Color: Transparent

Quantity per unit: 25



PromoSign/PromoLabel/PromoLabelaqua dish and bowl clip

Application: For use in fresh goods counters.

Existing of:

Description ■ Art. no.: Color: white ■ Art. no.: Color: black

Bowl holder 8316043 9211568

Distance joint, 5 cm 8316047 9211566

Cassette adaptor 8329800 9211565

Material: POM

Quantity per unit: 25



PromoSign/PromoLabel/PromoLabelaqua tray clip

Application: For use in fresh goods counters.

Existing of:

Description ■ Art. no.: Color: white ■ Art. no.: Color: black

Baking tray holder 8316042 9008342

Distance joint, 5 cm 8316047 9211566

Cassette adaptor 8329800 9211565

Material: POM

Quantity per unit: 25

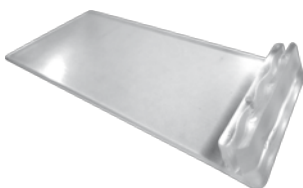

Card holder

Application: Fixing device for small signs.

■ Art. no.: 8311775

Size: 35 x 80 mm

Material: PVC

Color: Transparent

Quantity per unit: 10

PROMOSIGN/PROMOLABEL ACCESSORIES



PromoSign/PromoLabel/PromoLabelaqua universal clip

Application: For use in fresh goods counters.

Existing of:

Description	■ Art. no.: Color: white	■ Art. no.: Color: black
Universal holder	8316049	9211564
Cassette adaptor	8329800	9211565

Material: POM

Quantity per unit: 25



Service counter stand for price display

Photo: Stand with base plate.

Application: Holder for price tickets or holders. To be used in service counters (delicatessen, meat, cheese etc.).

In combination with the multi-clip adaptor (9178525), see below.

■ Art. no.:	Height till the lower edge of the cassette
9138729	10 cm
9138731	20 cm

Material: Stainless steel

Color: Silver

Quantity per unit: 1

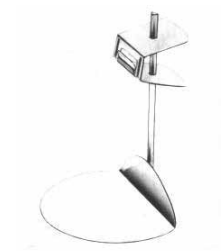

Multi-Clip UC 50

Application: Clamp, 50 mm width, for universal fixing of all PromoSign cassettes with multi-clip adaptor (9178525), see below.

■ Art. no.: 9116287

Material: Polycarbonate

Color: Transparent

Height: 75 mm

Width: 50 mm

Quantity per unit: 10



Multi-Clip UC 20

Application: Clamp, 20 mm width, for universal fixing of all PromoSign cassettes with multi-clip adaptor (9178525), see below.

■ Art. no.: 9129998

Material: Polycarbonate

Color: Transparent

Height: 72 mm

Width: 27 mm

Quantity per unit: 30



Multi-Clip-Adapter

Application: For attachment of PromoSign cassettes to multi-clips and to the service counter stands.

■ Art. no.: 9178525

Material: PVC

Color: Transparent

Quantity per unit: 10



PRICE CARD FIXINGS

Price card stands

Application: For price cards to 0.8 mm thickness. For extension cassette 7424 SB Expiry date.
(Extension cassette Expiry date p. 53).

■ Art. no.: Height bottom edge price card

9480147	5 cm
9480149	10 cm
9480151	15 cm

Material: PP
Color: Transparent

Quantity per unit: 25



Price card stands

Application: For price cards to 0.8 mm thickness.

■ Art. no.: Height bottom edge price card

9480146	5 cm
9480148	10 cm
9480150	15 cm

Material: PP
Color: Transparent

Quantity per unit: 25



Universal clip & card holder

Application: Universal clip to fix price cards.

Description ■ Art. no.: Color: white ■ Art. no.: Color: black

Universal clip	8316049	9211564
Card holder	8316042	9008342

Material: POM

Quantity per unit: 25

Card holder

Application: Holder for price cards.

■ Art. no.: 8311775

Material: PVC
Color: Transparent

Quantity per unit: 10

PRICE CARDS FIXINGS



Multi-Clip UC 50

Application: Clamp, 50 mm width, for universal fixing of price cards.

■ Art. no.: 9116287

Material: Polycarbonate
Color: Transparent
Height: 75 mm
Width: 50 mm

Quantity per unit: 10



Multi-Clip UC 20

Application: Clamp, 20 mm width, for universal fixing of price cards.

■ Art. no.: 9129998

Material: Polycarbonat
Color: Transparent
Height: 72 mm
Width: 27 mm

Quantity per unit: 30



Card clip adaptor

Application: To connect price cards to several PromoSign / PromoLabel fixings as follow on pages 65, 66.

■ Art. no.: 9479200

Material: Polypropylen
Color: Transparent

Quantity per unit: 25



Individual stand

Application: To be used in service counters (delicatessen, meat, cheese etc.) in combination with card clip adaptor (Art. no. 9479200).

■ Art. no.: | Height bottom edge price card

8327200 | 5 cm

8327201 | 10 cm

8328007 | 15 cm

Material: PC
Color: Transparent

Quantity per unit: 25



Individual stand with information on the back

Application: For the insertion of sales information in the back of the stand in combination with card clip adaptor (Art. no. 9479200).

■ Art. no. 8327210

Maße: 47 x 63 mm / Text insert 40 x 60 mm
Material: PP
Color: Transparent

Quantity per unit: 25

PRICE CARDS FIXINGS



Universal stand for price cards

Application: Transparent stand for service counters in combination with card clip adaptor (Art. no. 9479200).

■ Art. no.: 9465799

Size: 70 x 54 mm / 98 x 54 mm

Material: Styrolux

Color: Transparent

Quantity per unit: 25



Ice spit for Promolabelaqua

Application: Semi-transparent accessory spit to fix price cards in crushed ice (service counters) in combination with card clip adaptor (Art. no. 9479200).

■ Art. no.: 9470845

Length: 175 mm

Material: PC

Quantity per unit: 25



Acrylic stands for price cards

Application: Acrylic stands, especially designed to place between meat trays with slated edges in combination with card clip adaptor (Art. no. 9479200).

■ Art. no.: | Height

9483406 | 5 cm

9483407 | 8 cm

Material: Acrylic glass, 2 mm

Color: Transparent

Quantity per unit: 25

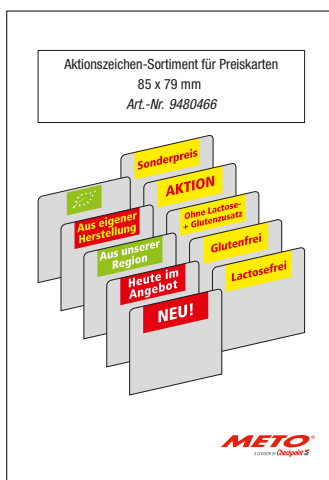

Special offer sign range for price cards

Photo: German-language version.

Application: Special offer signs to attach on the back of price cards.

■ Art. no.: 9480466

Format: 85 x 79 mm

Material: PVC, 0,3 mm

Quantity per unit: 10 signs per 12 pieces





FIXING SOLUTIONS

DECOLINE SUSPENSION TUBE

DecoLine suspension tubes: light, sturdy and usable anywhere – your ideal fixing solution

Suspension tubes from METO deliver what they promise. They offer the ideal foundation for the effective sales promotion labeling of merchandise in your store. There is also an extensive range of accessories available for practically all multifunctional fixture system requirements.







Your benefits

- Your price signage and special offer information can be placed right with the merchandise.
- Suspension tubes are simple to install since the accessories can be easily inserted.
- Thanks to the use of sturdy lightweight materials, even larger constructions can be created without difficulty.
- In combination with the extensive range of accessories, these suspension tubes allow you to make your design concepts reality.
- A wide range of Colors is available to create an elegant look in your store.



Suspension tubes

Application: Light, sturdy aluminium suspension profiles with two grey end caps for suspending price displays, frames etc. Can be used in combination with PVC position rails and hooks for suspension rails.

Art. no.:	Color
9114263	silver, anodised 
9114264	white RAL 9016 
9118359	yellow RAL 1021 
9124124	red RAL 3000 
9124120	blue RAL 5015 
9124125	green RAL 6024 
9133762	grey RAL 7005 

Material: Aluminium
Length: 200 cm

Quantity per unit: 1

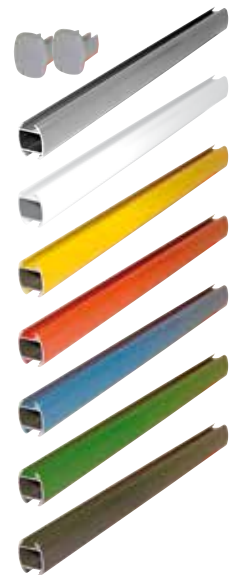

DECOLINE SUSPENSION TUBE ACCESSORIES

DECOLINE SUSPENSION TUBE ACCESSORIES



Suspension hooks for suspension tubes

Application: Plastic hooks to be inserted into the aluminium profiles. For hanging aluminium profiles; can be slid along the profile.

- Art. no.: 9114266 (25 pieces per unit)
- Art. no.: 9178365 (10 pieces per unit)

Material: Polycarbonate
Color: Transparent
Length: 20 mm



Eco connector for suspension tubes

Application: Plastic connector to be inserted into the aluminium profiles. Allows the connection of two aluminium profiles. Plug-in connection, no screws required. Not visible from the outside.

- Art. no.: 9178369

Material: PA and GF
Color: Grey RAL 7005
Length: 160 mm



Quantity per unit: 10



Corner connector for suspension tubes

Application: Plastic connector to be inserted into the aluminium profiles. Allows the connection of two aluminium profiles. Plug-in connection, no screws required.

- Art. no.: 9410482

Material: PA and GF
Color: Grey RAL 7005
Length: 73.5 mm



Quantity per unit: 2

DECOLINE SUSPENSION TUBE ACCESSORIES



Cross connector for suspension tubes

Application: Plastic connector to be inserted into the aluminium profiles. Allows the connection of four aluminium profiles. Plug-in connection, no screws required.

■ Art. no.: 9410484

Material: PA and GF
Color: Grey RAL 7005
Length: 145.5 mm

Quantity per unit: 2



T-connector for suspension tubes

Application: Plastic connector to be inserted into the aluminium profiles. Allows the connection of 3 aluminium profiles. Plug-in connection, no screws required.

■ Art. no.: 9410483

Material: PA and GF
Color: Grey RAL 7005
Length: 145.5 mm

Quantity per unit: 2



Position rail suspension tube, suspension rail & PosterLine

Application: Perforated plastic profile. Can be used in combination with suspension rails, suspension tubes and PosterLine. For exact positioning of poster mounts, price displays, frames etc. above the goods.

■ Art. no.: 9113995

Material: PVC
Color: Transparent
Length: 200 cm

Quantity per unit: 5

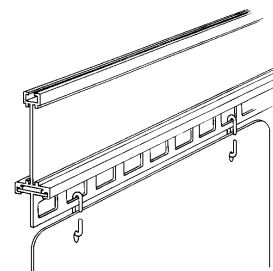

SUSPENSION RAIL & ACCESSORIES



Suspension rail

Application: Aluminium profile with two end-caps. For suspending posters, price displays, frames, etc. from ceilings. Suitable for hanging heavy displays.

■ Art. no.: 8310600

Material: Aluminium
Color: Silver, anodised
Length: 200 cm



Allows the insertion of shelf strips (39 mm)

Quantity per unit: 1



Suspension rail connector

Application: Allows the connection of two suspension rails.

■ Art. no.: 8310622

Material: Aluminium
Color: Silver, anodised

Quantity per unit: 1



Hooks for suspension rails / tubes and PosterLine

Application: For hanging poster mounts, price displays, frames etc. Accessories for suspension rails, suspension tubes and PosterLine.

■ Art. no.: 8310695

Material: Polycarbonate
Color: Transparent

Quantity per unit: 25



POSTERLINE & ACCESSORIES



PosterLine

Application: Light profile for attachment to walls or suspension from the ceiling for the display of price or information posters in formats ranging from DIN A5 portrait to DIN A3 landscape. Extruded polystyrene profile in standard Color grey RAL 7035 (customised Colors on request) for the simple and professional display of posters, packed in a polythene bag with cardboard edge-protectors, including fitting instructions.

Art. no.:	Description	Length	Quantity per unit
9008028	PosterLine DIN A5	2 m	2
9004475	PosterLine DIN A4	2 m	2

Material: Polystyrene (PS), suitable for indoor use only
Color: Light grey RAL 7035 (other Colors on request)



Posterline end caps

Application: For PosterLine DIN A5 and A4.

Art. no.:	Format	Quantity per unit
9135765	DIN A5	4
9135764	DIN A4	4

Material: PS
Color: Light grey RAL 7035



Posterline wall-mounting accessories

Application: For the attachment of PosterLine DIN A4 and DIN A5 to the wall. System consists of: 20 wall-mounting adaptors, 20 wall plugs, 6 x 60 mm.

Art. no.: 9004344

Material: PC + GF (wall-mounting adaptors)

Quantity per unit: 1



Posterline connector

Application: For connecting two PosterLine profiles together, including four screws.

Art. no.: 9010690

Material: PA6-GF30
Color: Light grey RAL 7035

Quantity per unit: 2



Posterline hooks

Application: For hanging PosterLine from the ceiling.

Art. no.: 9008080

Material: Polycarbonate
Color: Light grey RAL 7035

Quantity per unit: 20



CEILING FIXTURES



Ceiling hooks for grid ceilings

Application: For attachment to grid ceilings (Odenwald ceilings).

■ Art. no.: | Quantity per unit

8350283 | 20

8311104 | 250

Length: 75 mm

Thickness: 1.5 mm

Material: Metal, rustproof

Color: Silver

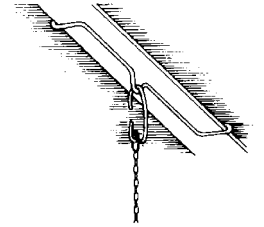

Ceiling clips for grid ceilings

Application: Ceiling clip for easy installation and deinstallation with standard grid ceilings (Odenwald ceilings). Can be released by simply pressing the sides. The clip tightens automatically when weight is applied.

■ Art. no.: 9217859

Format: 26 x 27.7 mm

Material: PA6 GF15

Color: White RAL 9010

Quantity per unit: 100



1.5 kg



3 kg



6 kg

Ceiling magnets

Application: For attachment to metal surfaces. With a fixed closed eyelet.

■ Art. no.: | Load-bearing capacity | Quantity per unit

8311120 | 1.5 kg | 20

8311121 | 3.0 kg | 20

8311122 | 6.0 kg | 10

Material: PVC

Color: White (housing)

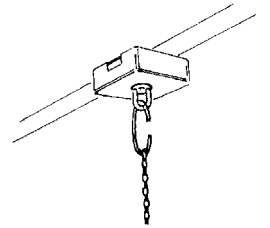

CEILING FIXTURES



S-hooks

Application: Universal connectors for the connection of two elements.

■ Art. no.: | Size

9122945 | 20 mm

9139971 | 28 mm

Material: Stainless steel

Color: Grey

Quantity per unit: 100



C-hooks

Application: Universal connectors for the connection of two elements.

■ Art. no.: | Quantity per unit

8350286 | 20

8311102 | 250

Length: 40 mm

Material: Stainless steel

Color: Silver

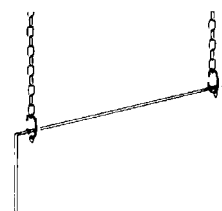

Hooks for tubes

Application: For attachment to tubes with a diameter of no more than 35 mm.

■ Art. no.: 8311103

Material: Stainless steel

Color: Silver

Quantity per unit: 250

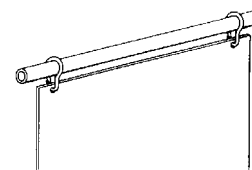

Self-adhesive hooks

Application: For attachment to flat surfaces.

Self-adhesive fixing device with a rotating eyelet.

Load-bearing capacity 25 kg,

■ Art. no.: 8311130

Material: PVC

Color: White

Quantity per unit: 100

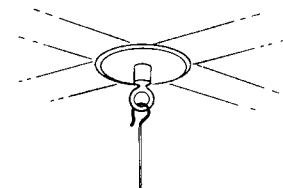

CEILING FIXTURES



6 kg



30 kg



88 kg



Chain

Application: Chain for suspending rails, posters, price displays, frames, etc. from the ceiling. Supplied on a roll.

Art. no.	Description	Load-bearing capacity	Length
8311125	Deco chain V12	6 kg (V12)	25 m
8311126	Knot chain K10	30 kg (V10)	30 m
8351015	Knot chain K16	88 kg (K16)	25 m

Material: Nickel-plated steel, rustproof
Color: Silver

Quantity per unit: 1

Steel cable

Application: Fixing device for hanging from the ceiling. Supplied on a roll. Cable for suspending rails, poster covers, price displays, frames, etc. To be used in combination with clamps for steel cable. For heavy-duty use (0.93 kN minimum breaking load).

Art. no.: 9180758

Length: 100 m
Thickness: 1 mm
Material: Galvanised steel
Color: Silver

Quantity per unit: 1



Clamps for steel cable

Application: For securing steel cables (pliers required). To be used in combination with steel cable.

Art. no.	for steel cable
9138714	8 mm thick
9208755	1 mm thick

Length: 5 mm
Material: Lead
Color: Silver

Quantity per unit: 100

CEILING FIXTURES



Suspension rods

Application: For suspending rails, posters, price displays, frames, etc. – in fixed lengths.

Art. no.:	Length
8350333	100 cm
8350332	70 cm
8350330	30 cm
8350329	15 cm

Thickness: 2 mm
Material: Nickel-plated steel, rustproof
Color: Silver

Quantity per unit: 100

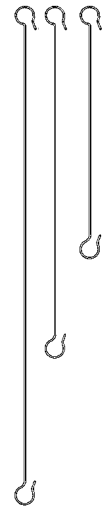

QuickFix professional suspension system

Application: Adaptor clamp for steel cables to facilitate the quick and easy installation of suspension tubes and PosterLine. In order to install suspension rails, the extra suspension fitting (9113997) is also required. Continuously adjustable for accurate alignment. Including metal plate insert for static loads of up to 10 kg.

System consists of: Adaptor clamp with metric ISO thread (M3) and metal plate.

Art. no.:	Quantity per unit
9210476	50
9405906	10

Material: Nickel-plate, metal plate: Galvanised steel

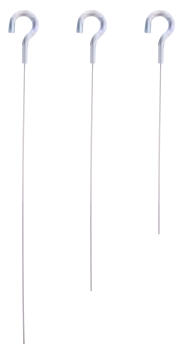

Steel cable for QuickFix professional suspension system

Application: Suitable 1.2 mm-thick steel cable in three lengths with fixed hook on one end. For fast and professional mounting of your suspension system.

Art. no.:	Length steel cable
9210478	90 cm
9210479	120 cm
9210480	150 cm

Material: Galvanised steel

Quantity per unit: 50



Clip profile 60/84 cm

Application: Extruded clip profile for holding posters in formats DIN A2 / DIN A1 landscape.

Art. no.:	Length
9114412	60 cm (for DIN A2 landscape)
9114409	84 cm (for DIN A1 landscape)

Material: PVC
Color: Transparent

Quantity per unit: 50



FRAMING SOLUTIONS

PLASTIC FRAMES



Poster frames DIN A3 – DIN A6







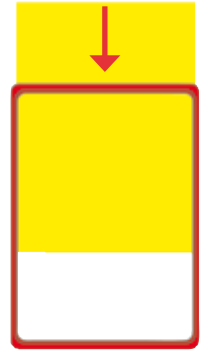



Application: DIN plastic frame for suspending or standing. Individual fixing solutions for all areas within the store. Robust and easy to handle. The posters are simply slipped into the individually attached frames, minimising demands on personnel, time and cost. Whether it be complete systems or individual elements, with modular frame systems you can achieve clear and attractive sales promotion that is precisely tailored to your merchandise areas and individual wishes.

Material: ABS
Further RAL colors on request.

Quantity per unit: 10



Poster inserted from above

Art. no.: DIN A3	Art. no.: DIN A4	Art. no.: DIN A5	Art. no.: DIN A6	Color	
8312531	8312541	8312551	8312561	green RAL 6024	
8312533	8312543	8312553	8312563	red RAL 3000	
8312535	8312545	8312555	8312565	blue RAL 5015	
8312536	8312546			yellow RAL 1021	
8312537	8312547	8312557		white RAL 9016	
8312538	8312548	8312558	8312568	black RAL 9005	
8312539	8312549	8312559		grey RAL 7040	
8312571	8312594	8312598	8377533	transparent	
8373210	8312599	8372461		light grey RAL 7035	
	9170487			aluminium grey RAL 9007	
Poster format:	420 x 297 mm	297 x 210 mm	210 x 148 mm	148 x 105 mm	
Outer dimensions:	430 x 307 mm	307 x 220 mm	220 x 158 mm	151 x 112 mm	
Inner dimensions:	421 x 301 mm	298 x 214 mm	151 x 216 mm	149 x 104 mm	
Profile width:	11 x 13 mm	11 x 13 mm	11 x 12 mm	11 x 10 mm	
Insert width:	2 mm	3,5 mm	3,5 mm	2 mm	

ACCESSORIES FOR PLASTIC FRAMES



Transparent plastic covers

Application: Transparent plastic covers, used with frames to protect inserted posters. Due to the non-reflective surface, information can be read under all lighting conditions. The plastic covers also allow the use of thinner card or paper. All protective covers are centre-folded.

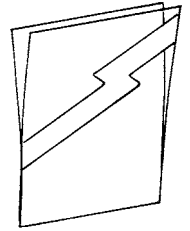

Art. no.:	Format	Thickness
8312641	DIN A1	0.3 mm
8312642	DIN A2	0.3 mm
8312643	DIN A3	0.2 mm
8312644	DIN A4	0.2 mm
8312675	DIN A4 cross	0.2 mm
8312645	DIN A5	0.2 mm
8312670	DIN A6	0.2 mm

Material: PVC
Color: Transparent, non-reflective

Quantity per unit: 10

ACCESSORIES FOR PLASTIC FRAMES



Suspension hook, fixed

Application: Clip with fixed hook for suspending individual frames vertically.

Art. no.: 8312617

Size: 15 x 16 mm and hook 57 mm
Material: Polycarbonate
Color: Transparent

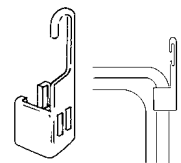

Quantity per unit: 24 (12 left side, 12 right side)



Suspension hook, moveable

Application: Clip with moveable hook for suspending individual frames, specially suitable for baskets or similar uses.

Art. no.: 8312606

Size: 15 x 16 mm and hook 45 mm
Material: Polycarbonate
Color: Transparent

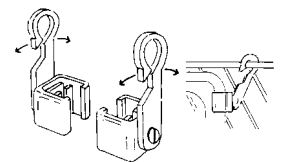

Quantity per unit: 25 (13 left side, 12 right side)



ACCESSORIES FOR PLASTIC FRAMES



Suspension hook, top, fixed

Application: Attachment clip for frames with side insert.

■ Art. no.: 9142020

Size: 16 x 14 x 39 mm
Material: Polycarbonate
Color: Transparent

Quantity per unit: 25

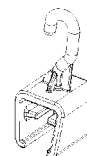

Tube hook for frames

Application: Clip with moveable hook for suspending individual frames on tubes with Ø up to 25 mm.

■ Art. no.: 8312616

Size: 35 x 62 x 20 mm
Material: Polycarbonate
Color: Transparent

Quantity per unit: 25 (13 left side, 12 right side)

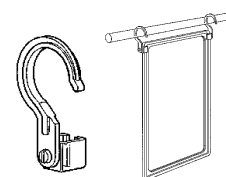

Suspension clip with eyelet, rotating

Application: Clip with rotating eyelet for suspending individual or vertically combined frames.

■ Art. no.: 8312604

Size: 28 x 15 x 16 mm
Material: Polycarbonate
Color: Transparent

Quantity per unit: 25

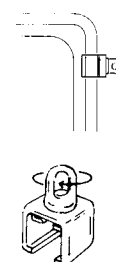

Tube clamp, rotating

Application: For fixing frames to tubes.

■ Art. no.:	For tubes of Ø	Size
8312612	18 mm	42 x 23 x 16 mm
8312574	22 mm	45 x 27 x 16 mm
8312613	26 mm	48 x 32 x 16 mm

Material: Polycarbonate
Color: Transparent

Quantity per unit: 25

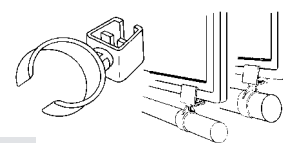

ACCESSORIES FOR PLASTIC FRAMES



Oval tube clamp with G-adaptor, rotating

Application: For fixing frames to tubes with oval cross-section.

■ Art. no.: 8312614

Size: 100 x 71 x 26 mm
Material: Polycarbonate
Color: Transparent

Quantity per unit: 25

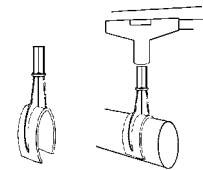

Suction clip adaptor for frames, rotating

Application: For fixing frames A6 – A3 format onto smooth surfaces (windows, sheets of glass), both horizontally or at a 90° angle to the surface. Two-part fixture, consisting of 1 suction clip plus a mounted frame adaptor.

■ Art. no.: 8312615

Suction clip
Size: 12 x 12 x Ø 40 mm
Material: PVC
Color: Transparent

Frame adaptor
Size: 15 x 15 x 15 mm
Material: Polycarbonate
Color: Transparent

Quantity per unit: 20

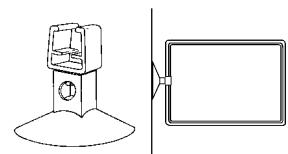

Frame magnet

Application: For fixing smaller frames to metal surfaces.

■ Art. no.:	Capacity	Size (magnet)	Color	Feature
8312607	1.5 kg	33 x 13 x 13 mm	white	1 swivel adaptor
8372239	1.5 kg	33 x 13 x 13 mm	black	1 swivel adaptor
8312575	3 kg	39 x 34 x 14 mm	white	1 swivel adaptor
9420994	3 kg	39 x 34 x 14 mm	black	1 swivel adaptor
8312608	3 kg	39 x 34 x 14 mm	white	2 swivel adaptors
8371059	3 kg	39 x 34 x 14 mm	black	2 swivel adaptors

Material: Housing: PA 6 · Clip: Polycarbonate

Quantity per unit: 25

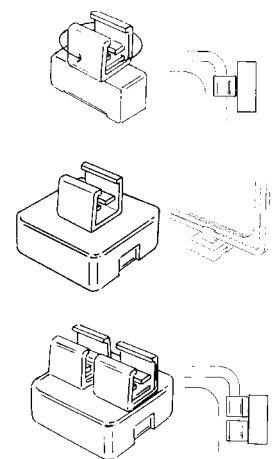

Frame wall magnet – 3 kg

Application: For fixing frames to metal surfaces, parallel to the fixing surface.

■ Art. no.:	Size (magnet)	Color
8312609	39 x 34 x 14 mm	white
9135940	39 x 34 x 14 mm	black

Material: Housing: PA 6 · Clip: Polycarbonate

Quantity per unit: 25

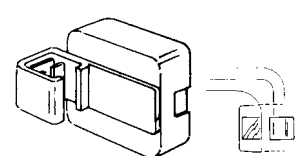

ACCESSORIES FOR PLASTIC FRAMES



Clip-on card holder

Application: Holder for clipping additional information to the frame.

■ Art. no.: 8312610

Size: 15 x 16 x 30 mm
Material: Polycarbonate
Color: Transparent

Quantity per unit: 25

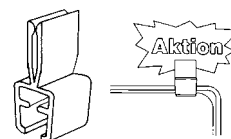

Frame connector, fixed

Application: Consists of 2 mounted parts for fixing several frames together, in a vertical or horizontal position.

■ Art. no.: 8312602

Size: 31 x 15 x 16 mm
Material: Polycarbonate
Color: Transparent

Quantity per unit: 25

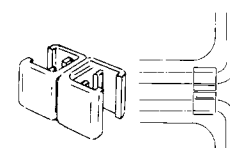

Swivel clip for frames

Application: For fixing frames A6 – A4 format by means of adhesive or screws to walls or shelves. Adhesive tape included.

■ Art. no.: 8312151

Size: 20 x 48 x 20 mm
Material: Polycarbonate
Color: Transparent

Quantity per unit: 20

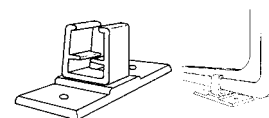

Frame holder

Application: For fixing frames to triangular deep-freeze rail (8310663 / 9100854).

Fixing accessory for deep-freeze system.

■ Art. no.: 8310610

Size: 25 x 25 x 22 mm
Material: Polycarbonate
Color: Transparent

Quantity per unit: 20

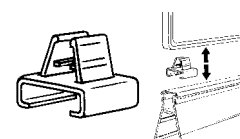

ACCESSORIES FOR PLASTIC FRAMES



Frame fixing profile

Application: For fixing frames and special offer clips onto even surfaces (deep freeze area, shelves etc.), in combination with frame holder 8310610. Extruded fixing profile with adhesive foam tape.

■ Art. no.: 9160230

Length: 1.24 m
Material: PVC
Color: White

Quantity per unit: 10



Frame clamp

Application: Adjustable clamp for universal fixing of all types of frames to boxes and trays (wood / plastic).

■ Art. no.: 9173219

Material: Polycarbonate
Color: Transparent

Quantity per unit: 10

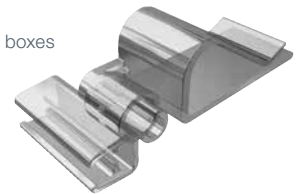

PromoSign frame clips

Application: Clips for fixing frames or PromoSign cassettes for parallel attachment to shelf edges or sheets. Consisting of 25 PromoSign clips and 25 frame clips.

■ Art. no.: 9143735

Size: 25 x 10 mm
Material: Polycarbonate / POM
Color: Transparent / white

Quantity per unit: 25



Fruit & vegetables box clamp for frames

Application: Clamp for universal fixing of all types of frames to boxes and trays (wood / plastic). Can be set at two different heights.

■ Art. no.: 9173217

Material: ABS
Color: Black

Quantity per unit: 10



ACCESSORIES FOR PLASTIC FRAMES



Frame base stand universal

Application: Permits 3 different stand positions by adjusting the position of the clip: vertical – inclined by 15° – inclined by 30°. 2 stands required per frame.

■ Art. no.: 8312650

Size: 150 x 22 x 10 mm (without clip)
Material: Polycarbonate
Color: Transparent

Quantity per unit: 20

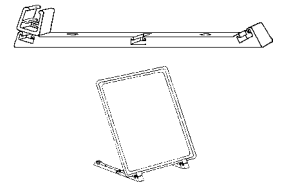

Variable frame holder

Application: Frame attachment consisting of baseplate and frame adaptor, with 7 different positions.

■ Art. no.: 9005272

Size: 200 x 90 mm
Material: ABS
Color: Transparent

Quantity per unit: 10

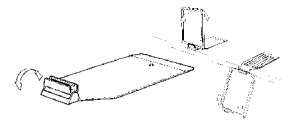







FRAME STANDS

FRAME STANDS



Frame stand

Application: Frame stands for DIN A3 and DIN A4 format, for use in portrait or landscape format. Consisting of poster frame, plastic telescopic tube with twist-lock (extendable to 60 cm), complete with G-adaptor and anthracite-grey metal base plate.





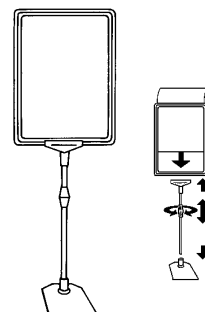

Art. no.: DIN A3	Art. no.: DIN A4	Color
	8312341	green RAL 6024 
8312333	8312343	red RAL 3000 
	8312346	yellow RAL 1021 
	8312345	blue RAL 5015 
	8312347	white RAL 9016 
	8312348	black RAL 9005 

Quantity per unit: 10



Frame stand

Application: Frame stands for DIN A3 and DIN A4 format, for use in portrait or landscape format. Consisting of poster frame, aluminium telescopic tube with plastic twist-lock (extendable to 60 cm), complete with G-adaptor and light grey metal base plate.

Art. no.: DIN A3	Art. no.: DIN A4	Color
	9485015	green RAL 6024 
9487156	9484601	red RAL 3000 
	9484964	yellow RAL 1021 
	9486449	blue RAL 5015 
	9486470	white RAL 9016 
	9486473	black RAL 9005 

Quantity per unit: 10



ACCESSORIES FOR FRAME STANDS

ACCESSORIES FOR FRAME STANDS



Metal base plate, standard

Application: For pallet stands, with welded screw stud and base holder attached.

Art. no.:	Color
8312631	dark grey
9484911	light grey

Size: 195 x 158 x 43 mm
 Weight: 374 g
 Material: Steel plate 2.0 mm stark

Quantity per unit: 10

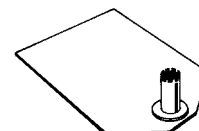

Plastic base plate

Application: For pallet stands, light-weight base plate.

Art. no.:	Color
8312655	dark grey
9484910	light grey

Size: 223 x 120 mm
 Weight: 84 g
 Material: ABS

Quantity per unit: 10

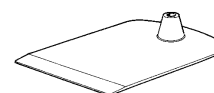

Tube adaptor for frame stands

Application: For fixed fitting to small areas, with adhesive tape.

Art. no.:	Color
8312636	dark grey
9484882	light grey

Size: Ø 34 mm, Height: 50 mm
 Material: Polycarbonate

Quantity per unit: 10



Telescopic tube

Application: Accessory for frame stands. Consisting of an outer and an inner tube (Ø 12 mm / Ø 9 mm), connected by a plastic screw fitting, including G-adaptor.

Art. no.:	Length outer and inner tube each	Extendable to	Material	Color
8312620	30 cm	60 cm	Plastic	dark grey
8312621	50 cm	100 cm	Plastic	dark grey
8312622	75 cm	150 cm	Plastic	dark grey
9484562	30 cm	60 cm	Aluminium	grey silver
9484565	50 cm	100 cm	Aluminium	grey silver
9484569	75 cm	150 cm	Aluminium	grey silver

Quantity per unit: 10

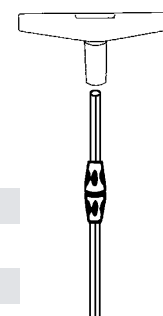

ACCESSORIES FOR FRAME STANDS



Spring-loaded holder for baskets

Application: For adjustable attaching to wire baskets, with light grey plastic adaptor for Ø 12 mm tubes. Clamp height extends to 42 cm, including 12 mm G-adaptor.

■ Art. no.: 9484272

Size: 540 mm in length, Ø 12 mm
Material: Aluminium
Color: Grey silver

Quantity per unit: 10

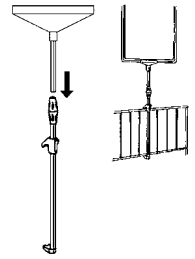

G-Adaptor

Application: Connecting part for frame stands, for attaching to telescopic tube, to hold poster frame. For tube with interior diameter of 9 mm (8312620 / -621 / -622).

■ Art. no.: 8312624

Size: 70 x 45 x 16 mm
Material: Polycarbonate
Color: Transparent

Quantity per unit: 10

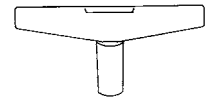

Pallet stand, heavy

Application: Pallet stand for plastic frames to attach posters to pallets.

Consisting of:

1 jumbo baseplate (8312231),
1 telescopic aluminium tube, 150 cm in length (8312232, extendable up to 225 cm) and 1 Super-G adaptor (8312630).

■ Art. no.: 8312229

Quantity per unit: 1

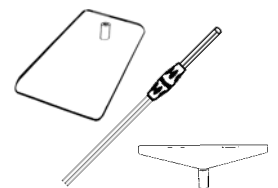

LIST HOLDER

LIST HOLDER



Info Vario list holder

Application: Ideal aid for cashiers for all unmarked articles; for up to 12 or 20 A4 lists (e.g. price lists, with/without barcodes) protected by plastic cover. Telescopic aluminium stand with 6 or 10 A4 frames in light grey. Extendable from 450 to 670 mm, angle tilt can be set in 2 positions, mounted on plastic base, fixed with four screws or adhesive pad.

Consisting of:

6 or 10 A4 frames

6 or 10 non-reflecting protective covers

1 telescopic stand

Screws, adhesive pad and instruction sheet

Art. no.:	Description	No. of frames
8312310	Vario 6	6 (non-extendible)
9007778	Vario 10	10 (non-extendible)

Format: 590 x 240 x 111 mm

Material: Aluminium, ABS, PA

Color: Holder: Black · frame: Grey RAL 7040

Quantity per unit: 1



LH 5 list holder

Application: Economical list holder for up to 10 price lists in A4 format, with adjustable metal foot. Practical solution for installing at the checkout. Telescopic fibreglass tube, extendable from 520 to 760 mm; plastic holder at top to hold 5 A4 frames in different Colors.

Consisting of:

1 metal baseplate

5 frames

10 attachment clips

Art. no.: 8311631

Size: 525 x 110 mm

Material: Plastic parts: Polycarbonate · frames: ABS

Color: Holder: Black · frames: Red, orange, blue, green, white

Quantity per unit: 1

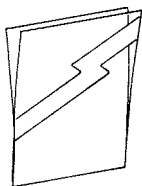
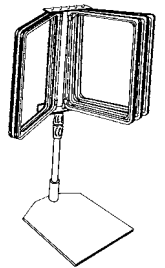

Plastic cover, DIN A4

Application: A4 replacement plastic covers for Info Vario and LH 5 list holders.

Art. no.: 8312644

Material: PVC

Thickness: 0.2 mm

Quantity per unit: 10

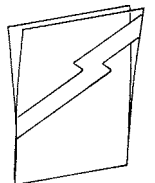

TRANSPARENT POSTER COVERS

TRANSPARENT POSTER COVERS



Hanging plastic poster covers

Application: Plastic poster covers with two eyelets for suspending from the ceiling.

Art. no.:	Format
9114621	DIN A1
9114622	DIN A2
9114623	DIN A3
9114624	DIN A4
9165778	DIN A4/A5 landscape (with welded seam)
9203824	2 x DIN A5 landscape (with welded seam)

Material: PVC
 Thickness: 0.4 mm
 Color: Transparent, non-reflective

Quantity per unit: 10

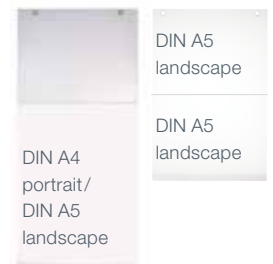
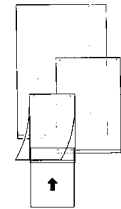

Plastic basket frame

Application: Plastic basket frame with two hooks for fixing signs to wire baskets.

Art. no.:	Format
9298554	DIN A4 landscape
9416381	DIN A4 portrait

Material: PVC
 Color: Transparent

Quantity per unit: 25



DIN A4 plastic poster cover with magnetic strip

Application: Plastic poster cover with two magnetic strips at rear for fixing signs on metal surfaces. Provides protection and facilitates changing posters.

Art. no.: 9446094

Material: PVC
 Thickness: 0.4 mm
 Color: Transparent, non-reflective

Quantity per unit: 10



Plastic shelf frames

Application: Plastic shelf frames with two magnets for fixing signs on metal shelves.

Art. no.: 8311411

Size: 21 x 7.3 cm
 Material: PVC
 Color: Transparent

Quantity per unit: 25

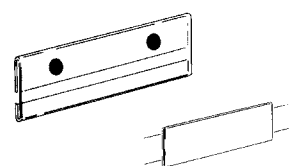

TRANSPARENT POSTER COVERS



Acrylic stands

Application: Free-standing plastic frames to place on counters.

Art. no.	Format	Material
8311405	DIN A4 portrait	acrylic, 0.4 mm
8311406	DIN A5 portrait	acrylic, 0.4 mm
8311407	DIN A6 portrait	acrylic, 0.4 mm
8311409	DIN A7 landscape	0.5 mm PVC, clear

Color: Transparent

Quantity per unit: 5

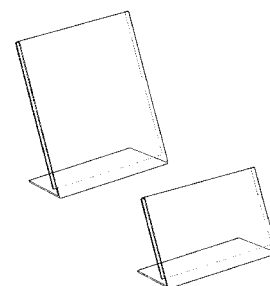

PVC pockets, self-adhesive

Application: PVC pockets for attaching to smooth surfaces.

Opening on one long side with offset front cover to facilitate inserting and replacing information.

Art. no.	Format
9445490	DIN A4 landscape
9445492	DIN A5 landscape
9445493	DIN A6 landscape
9445494	DIN A7 landscape

Thickness: Plasticized PVC clear 0.14 mm and SKF clear 0.10 mm

Material: Plasticized PVC clear, SKF clear

Color: Transparent

Quantity per unit: 25



Hooks for price displays

Application: For hanging price displays and transparent poster covers. For easy attachment to the position rail (9113995).

Art. no.: 9111388

Format: 32 x 41 mm

Material: POM

Quantity per unit: 20

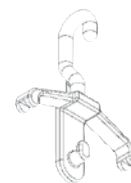

ALUMINIUM SNAP FRAMES

ALUMINIUM SNAP FRAMES





Aluminium snap frame, SlimLine

Application: Frame made from aluminium profiles, with black rubber seal, mitred corners, protective cover film, 1 PVC suction clip and four screws/dowels for attaching posters to walls. Particularly suitable for outdoor use (weather-resistant and waterproof).

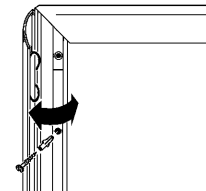
Backing sheet: Metal
 Profile thickness: 32 mm
 Protective cover film: PVC 0.8 mm, transparent, UV-resistant



Weather-resistant and waterproof

Profil 32 mm	Art. no.: DIN A1	Color
	8310401	silver, anodized 
	8310421	red RAL 3000 
Poster size:	841 x 594 mm	
Outer measurements:	860 x 650 mm	
Frame thickness:	20 mm	

Quantity per unit: 1



Aluminium snap frame, Standard

Application: Frame made from aluminium profiles, mitred corners, with backing sheet, protective cover foil and four screws/dowels for attaching posters to walls.

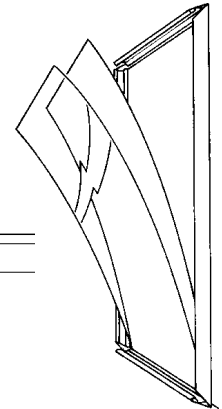

Backing sheet: Aluminium
 Profile thickness: 25 and 32 mm
 Protective cover: transparent, silk finish, 0.5 mm, UV-resistant



Profil: 25 mm

Art. no.: 9292167

Format: A4 **with rounded corners**
 Color: Anodized silver

Profil 32 mm	Art. no.: DIN A1	Color
	8310116	silver, anodized 
	8310132	red RAL 3000 
Poster size:	841 x 594 mm	
Outer measurements:	885 x 635 mm	
Frame thickness:	20 mm	

Quantity per unit: 1

PAVEMENT STANDS



SlimLine aluminium pavement stand

Application: For holding two posters, particularly suitable for use outdoors (weather-resistant and waterproof). SlimLine pavement stand, heavy-duty version with metal backing sheet, with black rubber seal, mitred corners, 1 PVC suction clip.

Profile thickness: 32 mm
 Backing sheet: Aluminium 0.75 mm thick
 Protective cover foil: Transparent PVC 0.8 mm, UV-resistant, waterproof

Weather-resistant and waterproof

Quantity per unit: 1

Profil 32 mm	Art. no.: DIN A1	Color
	8310451	silver, anodized <input type="checkbox"/>
	8310471	rot RAL 3000 <input type="checkbox"/>
Poster size:	841 x 594 mm	
Outer measurements:	1.105 x 655 mm	
Frame thickness:	96 mm	



Standard aluminium pavement stand

Application: For outdoor promotions, for holding two posters. Pavement stand, heavy-duty version with metal backing sheet.

Backing sheet: Aluminium
 Protective cover foil: Transparent 0.5 mm, non-reflective

Quantity per unit: 1

Art. no.: 70 x 100 cm	Art. no.: DIN A1	Color
8310205	8310117	silver, anodized <input type="checkbox"/>
	8310202	red RAL 3000 <input type="checkbox"/>
70 x 100 cm Poster size:	1.000 x 700 mm	
70 x 100 cm Outer measurements:	1.050 x 750 mm	
DIN A1 Poster size:	841 x 594 mm	
DIN A1 Outer measurements:	1.100 x 640 mm	
Frame thickness:	96 mm	
Profile thickness:	32 mm	

PAVEMENT STANDS

PAVEMENT STANDS



Rondo aluminium pavement stand

Application: Aluminium pavement stand with rounded, chromium-plated plastic corners for A1 format posters, including backing sheet and PVC foil.

■ Art. no.: 9219461

Poster size: DIN A1 (841 x 594 mm)

Profile thickness: 32 mm

Backing sheet: Steel, galvanised

Color: Silver, anodized

Protective cover foil: PVC, transparent, non-reflective

Quantity per unit: 1



Windmaster pavement stand

Application: Poster stand for outdoor use, that can even stand very strong winds. Easy to transport thanks to the castors in the base.

Base can be filled with water or sand. Fitted with snap frame technology with rounded corners, including UV-stabilised, non-reflective foil, that protects the poster from fading.

■ Art. no.: 9447135

Poster size: DIN A1 (841 x 594 mm)

Outer measurements: 1,248 x 812 mm

Profile thickness: 41 mm

Color: Silver, anodized

Protective cover foil: PVC, transparent, non-reflective

Quantity per unit: 1

REPLACEMENT FOILS

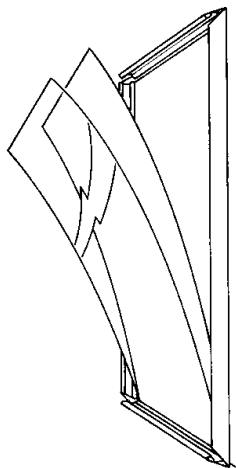

SlimLine protective cover

Application: Protects posters from the effects of the weather.
Non-reflective, deep-drawn protective poster cover made from UV-resistant material, antistatic. For the SlimLine aluminium snap frame and the SlimLine aluminium pavement stand.

Art. no.:	Poster format	Outer measurements	Inner measurements
8310390	DIN A0	1,215 x 867 mm	1,201 x 853 mm
8310391	DIN A1	867 x 620 mm	853 x 606 mm
8310392	DIN A2	620 x 446 mm	606 x 432 mm

Thickness: 0.8 mm
Material: PVC, transparent

Quantity per unit: 5

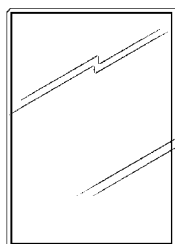

Standard replacement foil

Application: For protecting posters.
Non-reflective, protective poster foil, UV-resistant, antistatic.
For aluminium snap frame (Standard), window snap frame and aluminium pavement stand (Standard).

Art. no.:	Poster format	Size
8310120	DIN A0	1,189 x 841 mm
8310121	DIN A1	841 x 594 mm
8310122	DIN A2	594 x 420 mm

Thickness: 0.5 mm
Material: PVC, transparent

Quantity per unit: 1

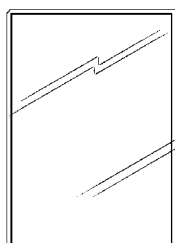

WindMaster replacement foil

Application: For protecting posters against the effects of the weather.
For the WindMaster pavement stand.

Art. no.: 9446475

Poster format: A1 (841 x 594 mm)
Material: PVC
Color: Transparent

Quantity per unit: 1

Heute
im
Angebot

CREATIVE DISPLAY SOLUTIONS

PERFORATED LABEL SHEETS

Perforated label sheets

Application: For printing labels for price cassettes. Compatible with laser and inkjet printers.

Art. no.:	Application	Label size	Labels per sheet
8329900	PromoSign 7424 counter (A)	70 x 23 mm	32
9237154	PromoSign 7424 info on rear (B)	60 x 45 mm	18
8329910	PromoSign 16038 F&V (C)	117 x 37 mm	10
8329912	PromoSign 21080 beverages (D)	210 x 80 mm	3
9326009	PromoLabel S (E)	70 x 49 mm	10
9237153	PromoLabel S Premium (F)	45 x 50,4 mm	20
9455123	PromoLabel BSM (G)	116 x 77 mm	3
9326008	PromoLabel M (H)	157 x 78 mm	3
9455124	Price label frame (I)	150 x 70 mm	4
9469018	PromoLabelaqua (K)	74 x 52 mm	10

Color: White
Paper weight: 120 g

Quantity per unit: 100 DIN A4 label sheets

Create text inserts (14 formats available) quickly and easily with the METO price tag editor (www.meto-pricetageditor.com).

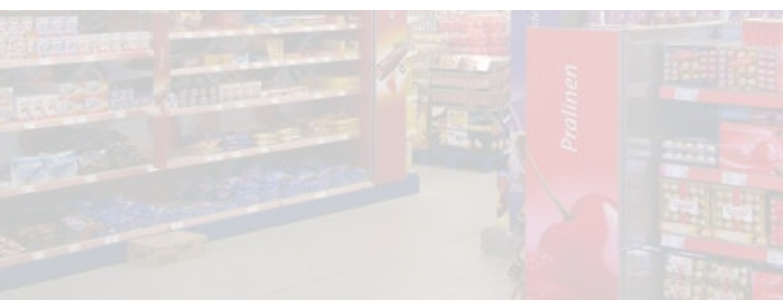
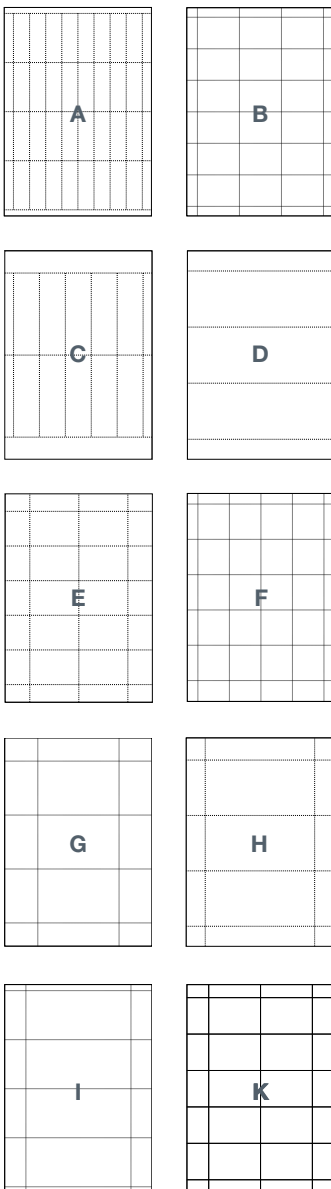

POSTER PAPER / CARTON / CHALKBOARDS





POSTER PAPER / POSTER CARTON

Poster paper, fluorescent colors

	■ Art. no.: DIN A0	■ Art. no.: DIN A1	■ Art. no.: DIN A2	■ Art. no.: 70 x 100 cm	Color
	8320405	8320415	8320425	8320455	fluorescent yellow 
Quantity per unit	50	100	200	50	

Paper weight: 80 – 90 g

Poster carton

	■ Art. no.: DIN A1	■ Art. no.: DIN A2	■ Art. no.: DIN A3	■ Art. no.: DIN A4	Paper weight	Color
Poster card "Casino"	8321211	8321221	8321231		250 g	white 
Poster card, fluorescent red	8321403			8321443	220 g	fluorescent red 
Poster card, fluo. yellow			8321831	8321841	300 g	fluorescent yellow, double-sided 
Quantity per unit	50	100	100	100		



CHALKBOARDS



Chalkboards

Application: For marking with poster pens. For use in plastic or aluminium snap frames. Double-sided screen-printed foil, both sides protected by a transparent laminate.

Material: PVC 0.8 mm

Color	■ Art. no.: DIN A2	■ Art. no.: DIN A3	■ Art. no.: DIN A4	■ Art. no.: DIN A5	■ Art. no.: 8 x 11 cm
black 	8311972	8311973	8311974	8311975	
black, green edges 					3300473
Quantity per unit	1	5	5	5	1

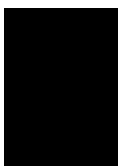

Chalkboard foil, self adhesive

Application: To stick on the back panels of aluminium snap frames or pavement stands. Marking with poster pens.

■ Art. no.: 9411864

Format: DIN A1

Material: PVC

Quantity per unit: 2

WRITING KITS / INK



Multi Line writing kit

Application: Writing kit for producing hand-written posters, consisting of a square ink container with 5 different sizes of felt writing pens (A, B, C, D, E). Each pen contains a double-ended felt tip, i.e. the writing tip can be reversed and re-used.

For use with METO standard ink or METO water-based ink.

Important: It is **not** possible to change from standard ink to waterbased ink – or vice-versa – using the same writing kit.

■ Art. no.: 9114149

Size: approx. 135 x 135 x 230 mm

- Writing pens: A - 14 x 18 x 147 mm
 B - 16 x 22 x 148 mm
 C - 20 x 33 x 163 mm
 D - 26 x 44 x 165 mm
 E - 28 x 58 x 175 mm

Color: Black

Quantity per unit: 1



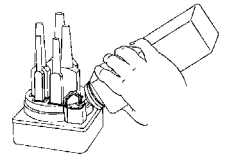

Ink for Multi Line writing kit

Application: METO offers two different types of inks: GreenLine (water-based) and ProfiLine (standard solvent-based). The ink bottle has a pouring cap with a cut-off spout and can be resealed with a Color-coded stopper.





These inks must not be mixed or used with other inks!

GreenLine Ink (water-based)

Art. no.	Color
8308050	black 
8308051	red 

ProfiLine Ink (standard solvent-based)

Art. no.	Color
8308030	black 
8308031	red 

Contents: 750 ml

Size: approx. 70 x 70 x 240 mm

Material: Bottle: Polypropylene

Quantity per unit: 1

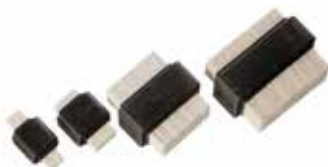

Felt writing tips for Multi Line writing kit

Application: Replacement parts for Multi Line writing kit.

Art. no.	Format
8308041	Size A 4.5 x 9.0 x 35.0 mm
8308042	Size B 7.0 x 14.0 x 40.0 mm
8308043	Size C 12.0 x 24.0 x 40.0 mm
8308044	Size D 17.0 x 34.5 x 40.0 mm
8308045	Size E 19.3 x 49.5 x 45.0 mm

Material: Pure wool

Quantity per unit: 5



Jet 4000 / 3000 writing kits

Application: Writing kit with four (Jet 4000) or three (Jet 3000) pens for producing hand-written posters. Including 2 lids (1x black, 1x red), depending on the ink Color.

	Jet 4000	Jet 3000
■ Art. Nr.:	8300205	8300215
Lid Color:	Black / red	Black / red
Diameter:	120 mm, height: 235 mm	90 mm, height: 210 mm
Writing widths:	Pen no. 1 7 + 10 mm	Pen no. 1 7 + 10 mm
	Pen no. 2 13 + 22 mm	Pen no. 2 13 + 22 mm
	Pen no. 3 15 + 37 mm	Pen no. 3 15 + 37 mm
	Pen no. 4 26 + 53 mm	



Quantity per unit: 1



Ink for Jet 3000 / 4000 writing kits

Application: Solvent-based ink for the Jet 3000 / 4000 writing kits.

These inks can not be mixed or used with other inks!

■ Art. no.:	Color
8301114	black 
8301110	red 

Contents: 1 litre

Quantity per unit: 1



Writing felts for the Jet 3000 / 4000 writing kits

Application: Spare parts for the Jet 3000 / 4000 writing kits.

■ Art. no.:	Pen no.	Format
8300341	Pen no. 1	7 x 10 x 100 mm
8300342	Pen no. 2	13 x 22 x 70 mm
8300343	Pen no. 3	15 x 37 x 70 mm
8300344	Pen no. 4	26 x 53 x 70 mm

Material: White wool

Quantity per unit: 1

Pot felts for the Jet 3000 / 4000 writing kits

Application: Spare parts for the Jet 3000 / 4000 writing kits.

■ Art. no.:	
3100046	Pot felt Jet 4000
3100050	Pot felt Jet 3000

Material: White wool

Quantity per unit: 1

WRITING KITS



Poster pens

Application: Poster pens with fibre wedge tip for writing widths of 2 and 5 mm or 10 and 15 mm. For writing on chalkboards or other non-absorbent surfaces such as glass, plastic, metal etc. Waterproof and odourless. Quick-drying on paper and cardboard. Cap Color shows ink Color. Ink is water-based.

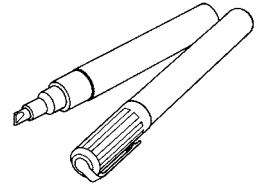

■ Art. no.: Pen width 2 / 5 mm	■ Art. no.: Pen width 10 / 15 mm	Color
8300231	8300241	5 x red
8300238	8300248	5 x white
8300239	8300249	5 x black

Packaging: 5 poster pens in a plastic bag

Quantity per unit: 5



Poster pen cleaner

Application: For wiping poster pen from chalkboards / whiteboards. Transparent bottle with spray nozzle.

■ Art. no.: 8300220

Contents: 750 ml

Size: 70 x 70 x 240 mm

Material: Bottle: Polypropylene

Quantity per unit: 1

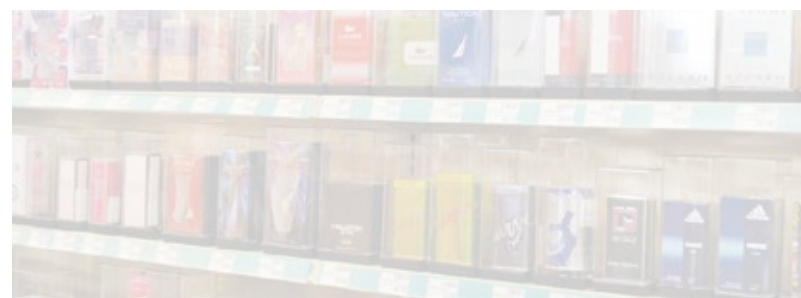



SHOPPING CONVENIENCE

SHOPPING BASKETS







Shopping basket with 1 or 2 handles

Application: Standard, stackable shopping basket for a comfortable shopping experience in five standard Colors, other Colors available on request.

Advantages

- For carrying, stackable
- Sturdy quality
- Customisable

■ Art. no.: 1 handle	■ Art. no.: 2 handles	Color
9410860*	9231329*	red RAL 3020 
9410131*	9410239*	blue Pantone 286 
9411835*	9410377*	green RAL 6024 
9410863*	9407870*	yellow RAL 1018 
9409948*	9410352*	black RAL 9005 



* Product on request, minimum order quantity 10 units

Material: Polyethylene (High Density)

Capacity: 22 litres

Weight: 670 g

Measurements: 430 x 300 x 230 mm

Quantity per unit: 1



Bobby, the rolling shopping basket

Application: Universally practical shopping basket on wheels, that can be carried or pulled along, taking the weight out of shopping!

Advantages

- Bobby increases the average time spent in the shop by 18 % (according to customer survey)
- Larger than an average shopping basket
- 2 handles for carrying or pulling along
- Lightweight and easy to manoeuvre
- Stackable, saves space when compared to shopping trolleys

■ Art. no.:	Wheels	Unit per quantity	Color
9200853	3 (2 with stainless steel rod, 1 multi-directional guide ball)	125	red 
9207267	3 (2 with stainless steel rod, 1 multi-directional guide ball)	10	red 

Material: Polyethylene (High Density)

Handles: Central handle made of polypropylene · extendible handle made of GFR polyamide

Capacity: 28 litres

Weight: 1.3 kg

Measurements: 520 x 355 x 345 mm



SHELF PRESENTATION SOLUTIONS

SHELF PRESENTATION SYSTEM OPTISELL 1



OS1 rail

Application: Rail for attaching shelf dividers and pushers to shelves.
Available with adhesive tape or magnetic strip.

Art. no.:	Version	Length	Color	
9426300	with adhesive tape	1,000 mm	white	<input type="checkbox"/>
9426301	with adhesive tape	1,250 mm	white	<input type="checkbox"/>
9426305	with magnetic strip	1,000 mm	white	<input type="checkbox"/>
9426308	with magnetic strip	1,250 mm	white	<input type="checkbox"/>
9426303	with magnetic strip	1,000 mm	grey RAL 9006	<input type="checkbox"/>
9426307	with magnetic strip	1,250 mm	grey RAL 9006	<input type="checkbox"/>
9426302	with magnetic strip	1,000 mm	anthracite RAL 7016	<input type="checkbox"/>
9426306	with magnetic strip	1,250 mm	anthracite RAL 7016	<input type="checkbox"/>

Quantity per unit: 10



↳ 22 mm ↳



OS1 rail, clip-in version

Application: Rail for attaching shelf dividers and pushers to Tego shelves.

Art. no.:	Length
9426309	989 mm
9426310	1,239 mm

Color: Light grey RAL 7035

Quantity per unit: 10



↳ 22 mm ↳



SHELF PRESENTATION SYSTEM OPTISELL 1



OS1 rail for labels

Application: Rail with adhesive tape for attaching shelf dividers and pushers to shelves with integrated label insert (39 mm label height).

■ Art. no.: Length

9448315	1,000 mm
9448318	1,250 mm

Color: White



Quantity per unit: 10

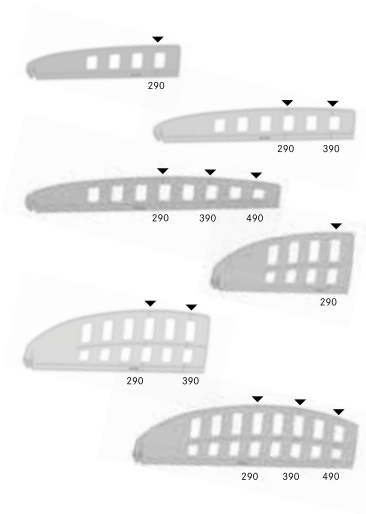

OS1 shelf divider

Application: For the tidy separation of goods on the shelf in order to make better use of the space available.

■ Art. no.: Size (H x L) | Pre-determined breakage point(s) at

9426268	65 x 340 mm	290 mm
9426269	65 x 440 mm	390 mm, 290 mm
9426280	65 x 540 mm	490 mm, 390 mm, 290 mm
9426281	120 x 340 mm	290 mm
9426282	120 x 440 mm	390 mm, 290 mm
9426266	120 x 540 mm	490 mm, 390 mm, 290 mm

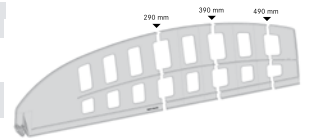

Material: Polystyrene

Color: Clear, transparent

(also available in frosted look and made of bioplastic)

Quantity per unit: 24



OS1 shelf divider, 140 x 600 mm

Application: For the tidy separation of goods and in order to make better use of the space available on the lowest shelf.

■ Art. no.: 9448313

Size: 140 x 600 mm

Material: Polystyrene

Color: Clear, transparent

(also available in frosted look and made of bioplastic)

Quantity per unit: 25

SHELF PRESENTATION SYSTEM OPTISELL 1 / OPTISELL 2



OS1 pusher

Application: The pusher ensures that the products on display are automatically pushed to the front of the shelf once an article has been removed. The pusher's case can simply be taken off, turned and placed back in order to change its position from straight to angular or vice versa.



Art. no.	Newton force	Model front stop	Length guiding profile
9426284	6	60 x 60 mm, angular	365 mm
9426285	6	60 x 60 mm, angular	415 mm
9426286	10	60 x 60 mm, angular	365 mm
9426287	10	60 x 60 mm, angular	415 mm
9426288	14	60 x 60 mm, angular	365 mm
9426283	14	60 x 60 mm, angular	415 mm
9438884	14	60 x 60 mm, straight	465 mm
9445280	14	60 x 60 mm, angular	465 mm

Material: Case: PS · Front stop: PC · Guiding profile: PVC
Color: Pusher: Grey · Front stop: Transparent

Further pusher combinations available on request.

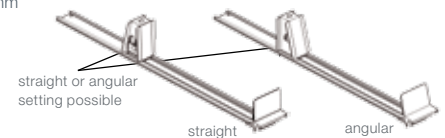

Quantity per unit: 10

SHELF PRESENTATION SYSTEM OPTISELL 2

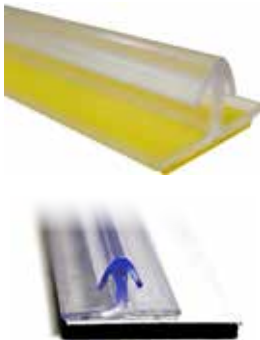

OS2 profile

Application: Profile for attaching shelf dividers and pushers to shelves. Available with adhesive tape or magnetic strip.



Art. no.:	Version	Length
9440393	with adhesive tape	970 mm
9438481	with adhesive tape	997 mm
9438482	with adhesive tape	1,247 mm
9448685	with magnetic strip	997 mm
9448686	with magnetic strip	1,247 mm

Color: Transparent

Quantity per unit: 1



OS2 L-shaped front profile

Application: Retaining profile for holding shelf dividers and pushers, with front panel, height 30 mm. Available with adhesive tape or magnetic strip.



Art. no.:	Version	Length
9448334	with adhesive tape	997 mm
9448335	with adhesive tape	1,247 mm
9448336	with magnetic strip	997 mm
9448337	with magnetic strip	1,247 mm

Color: Transparent

Quantity per unit: 1

SHELF PRESENTATION SYSTEM OPTISELL 2



OS2 adhesive profile for labels

Application: Profile with adhesive tape for attaching shelf dividers and pushers to shelves with integrated label insert (39 mm label height).

Art. no.	Length
9448332	997 mm
9448333	1,247 mm

Color: Transparent

Quantity per unit: 1



OS2 clip-in profile

Application: Profile for attaching shelf dividers and pushers to Tego shelves.

Art. no.	Length
9437610	989 mm
9437611	1,239 mm

Color: Transparent

Quantity per unit: 1



Lower part of OS2 clip-in profile

Application: As addition for the OS2 clip-in profile with label insert for labels of height 39 mm.

Art. no.	Length
9448319	989 mm
9448331	1,239 mm

Color: Back: Light grey · Front: Transparent

Quantity per unit: 1



OS2 clamp profile

Application: Profile for shelf dividers and pushers for inserting in the U-profile of the shelf edge, for use in combination with a front sheet.

Art. no.	Length
9445753	985 mm
9445755	1,235 mm

Color: Transparent

Quantity per unit: 1



SHELF PRESENTATION SYSTEM OPTISELL 2

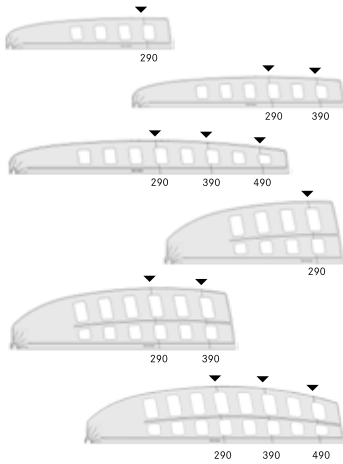

OS2 shelf divider

Application: For the tidy separation of goods on the shelf in order to make better use of the space available.

Art. no.	Size (H x L)	Breaking point(s) at
9426232	65 x 340 mm	290 mm
9426233	65 x 440 mm	390 mm, 290 mm
9426234	65 x 540 mm	490 mm, 390 mm, 290 mm
9426253	120 x 340 mm	290 mm
9426254	120 x 440 mm	390 mm, 290 mm
9426255	120 x 540 mm	490 mm, 390 mm, 290 mm

Material: Polystyrene
 Color: Clear, transparent
 (also available in frosted look and made of bioplastic)

Quantity per unit: 24

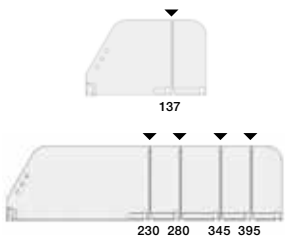
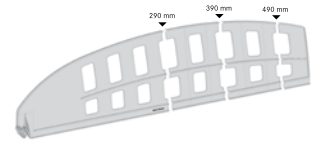

OS2 shelf divider

Application: For the tidy separation of goods on the shelf in order to make better use of the space available.

Art. no.	Size (H x L)	Breaking point(s) at
9426256	120 x 192 mm	137 mm
9426230	120 x 448 mm	395 mm, 345 mm, 280 mm, 230 mm

Material: Polystyrene
 Color: Clear, transparent
 (also available in frosted look and made of bioplastic)

Quantity per unit: 24

SHELF PRESENTATION SYSTEM OPTISELL 2

OS2 pusher

Application: The pusher ensures that the products on display are automatically pushed to the front of the shelf once an article has been removed. The pusher's case can simply be taken off, turned and placed back in order to change its position from straight to angular or vice versa.



Art. no.	Newton force	Model front stop	Length guiding profile
9456440	4	40 x 35 mm, straight	315 mm
9445259	4	40 x 35 mm, straight	365 mm
9443954	4	40 x 35 mm, straight	415 mm
9426221	6	40 x 35 mm, straight	225 mm
9433164	6	40 x 35 mm, straight	265 mm
9433167	6	60 x 60 mm, angular	265 mm
9433085	6	60 x 60 mm, straight	265 mm
9438378	6	40 x 35 mm, straight	315 mm
9427969	6	40 x 35 mm, straight	365 mm
9427959	6	60 x 60 mm, angular	365 mm
9443442	6	60 x 60 mm, straight	365 mm
9427970	6	40 x 35 mm, straight	415 mm
9427966	6	60 x 60 mm, angular	415 mm
9438379	10	40 x 35 mm, straight	315 mm
9468643	10	60 x 60 mm, angular	265 mm
9438483	10	60 x 60 mm, straight	315 mm
9443295	10	60 x 60 mm, angular	315 mm
9426259	10	40 x 35 mm, straight	365 mm
9426261	10	60 x 60 mm, angular	365 mm
9426260	10	40 x 35 mm, straight	415 mm
9426262	10	60 x 60 mm, angular	415 mm
9438400	14	40 x 35 mm, straight	315 mm
9438484	14	60 x 60 mm, straight	315 mm
9426263	14	40 x 35 mm, straight	365 mm
9426265	14	60 x 60 mm, angular	365 mm
9426264	14	40 x 35 mm, straight	415 mm
9433165	14	60 x 60 mm, straight	415 mm
9426257	14	60 x 60 mm, angular	415 mm
9433166	14	60 x 60 mm, straight	465 mm

Material: Case: PS · Front stop: PC · Guiding profile: PVC
Color: Pusher: Grey · Front stop: Transparent

Further pusher combinations available on request.

Quantity per unit: 10

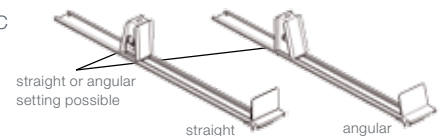

ACCESSORIES FOR SHELF PRESENTATION SYSTEMS OPTISELL 1+2

ACCESSORIES FOR SHELF PRESENTATION SYSTEMS OPTISELL 1+2

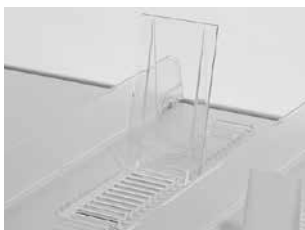

Mobile back rest, OS1 und OS2

Application: Support for product packaging on the shelf in combination with slide stop (OS1: 9426289 / OS2: 9426231).

■ Art. no.: 9426221

Size: 80 x 148 x 145 mm
Material: Polystyrene
Color: Transparent

Quantity per unit: 24

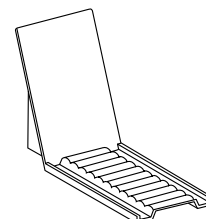

Slide stop

Application: For attaching to front rail/profile, helps to position and fix mobile back rest on shelf. Thanks to pre-defined breakage points can be shortened to fit the shelf depth.

■ Art. no.: System type

9426289 | Optisell1

9426231 | Optisell2

Size: 40 x 420 mm
Material: K-Resin
Color: Transparent

Quantity per unit: 24



Shelf divider clip with magnet, OS1 and OS2

Application: To fix shelf dividers to the back of the shelf, facilitates repositioning of the shelf dividers.

■ Art. no.: 9426225

Size: 6 x 16 x 17 mm
Material: Polycarbonate
Color: Transparent

Quantity per unit: 10

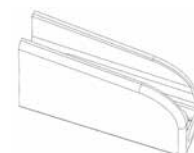

Adjusting rail, OS1 und OS2

Application: Fixing strip for shelf dividers, attached to the back of the shelf with adhesive tape or magnetic strip.

■ Art. no. | Version | Length

9426226 | with adhesive tape | 250 mm

9426228 | with adhesive tape | 500 mm

9426227 | with magnetic strip | 250 mm

9426229 | with magnetic strip | 500 mm

Color: Natural

Quantity per unit: 20



ACCESSORIES FOR SHELF PRESENTATION SYSTEMS OPTISELL 1+2



Rail clip set for shelf dividers, OS1 and OS2

Application: Additional protection for products on the shelf, contains: 1 rail with 6 clips, that can easily be attached to every second shelf divider (recommandation) by pushing together the top part of the clip. The clips hold the rail in place.

■ Art. no.: 9448482

Size: Clip: 41 x 22 x 8 mm · Rail: Ø 10 mm, Length: 124.5 cm

Material: Rail: Acrylic · Clip: Polystyrene

Color: Transparent

Quantity per unit: 1



Extra-large back plate for pusher, OS1 and OS2

Application: For clipping to the pusher to enlarge the support area for displaying larger product packaging.

■ Art. no.: 9426224

Size: 70 x 130 mm

Material: Polystyrene

Color: Grey

Quantity per unit: 10



Label holder, OS1 and OS2

Application: For clipping additional product information to the pusher.

■ Art. no.: 9426223

Size: 49 x 80 mm

Material: PVC

Color: Transparent

Quantity per unit: 10



ORDER ENTRY PROFILES / SHELF EDGE PROFILES

ORDER ENTRY PROFILES / SHELF EDGE PROFILES

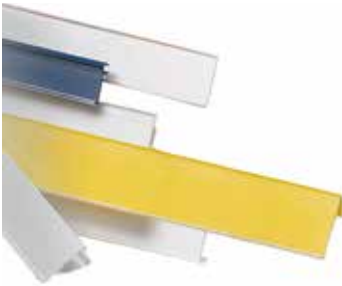

Order entry profiles

Application: Order entry profiles for sticking to all smooth, clean shelf edges.
Co-extruded profiles for labels from 13 – 107 mm in height, with integrated guiding strip for barcode scanners.

Length: 985 mm

- Art. no.: 8352428 (acrylic adhesive tape 12 mm)
- Art. no.: 8352430 (foam adhesive tape 12 mm)

Length: 1,235 mm

- Art. no.: 8352456 (acrylic adhesive tape 12 mm)
- Art. no.: 8352458 (foam adhesive tape 12 mm)

Label height: 40 mm
Front: Transparent
Color: Back panel white RAL 9010

Quantity per unit: 50



Order entry profile OEP 24A

Application: For labels up to 40 mm in height with acrylate adhesive tape 24 mm.

- Art. no.: 9128911

Length: 1,235 mm
Color: Front: Transparent · back panel: Transparent

Quantity per unit: 50



Order entry profile OEP WG 42/12 A

Application: For wooden and glass shelves. For labels up to 40 mm in height with acrylate adhesive tape 12 mm.

■ Art. no.:	Length
8352515	1,235 mm

Color: Front: Transparent · back panel: White RAL 9010

Quantity per unit: 50

ORDER ENTRY PROFILES / SHELF EDGE PROFILES

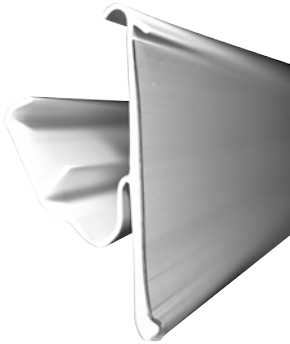

Shelf edge profile TLS 42

Application: For Tego, Linde and Storebest shelves. Co-extruded profile for labels up to 40 mm in height; adjustable to 15° and 45°.

Art. no.	Length	Back panel colour	
8352518	985 mm	white RAL 9016	<input type="checkbox"/>
8352519	1,235 mm	white RAL 9016	<input type="checkbox"/>
9178686	985 mm	transparent	<input type="checkbox"/>
9137108	1,235 mm	transparent	<input type="checkbox"/>
9464153	985 mm	grey RAL 7016	<input type="checkbox"/>
9464155	1,235 mm	grey RAL 7016	<input type="checkbox"/>

Front: Transparent

Quantity per unit: 50

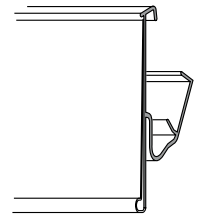

Shelf edge profile Tego 42 B

Application: For Tegometall shelves. For labels up to 40 mm in height.

Art. no.	Length
8352522	985 mm
8352523	1,235 mm

Color: Front: Transparent · back panel: White RAL 9010

Quantity per unit: 50

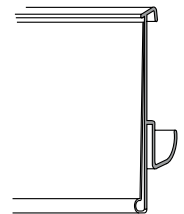

Shelf edge profile Kind 42

Application: For Kind shelves. For labels up to 40 mm in height.

Art. no.	Length	Back panel colour	
9136696	985 mm	white RAL 9016	<input type="checkbox"/>
9136699	1,235 mm	white RAL 9016	<input type="checkbox"/>
9179724	988 mm	transparent	<input type="checkbox"/>
9179681	1,235 mm	transparent	<input type="checkbox"/>

Quantity per unit: 25

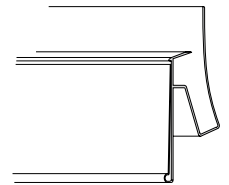

Shelf edge profile for Linde cooling shelf

Application: Order entry profile for attaching to Linde cooling shelf with fastening clip (9134691) for labels up to 40 mm in height.

Art. no.: 9134551

Length: 1,250 mm

Color: Front: Transparent · back panel: White

Quantity per unit: 40



Shelf edge profile Wire basket 42

Application: Order entry profile for wire baskets and shelf insert baskets (Ø up to 10 mm).

Art. no.	Length
9138550	980 mm
9487250	1,220 mm

Color: Front: Transparent

Quantity per unit: 50

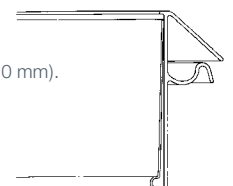

ACCESSORIES FOR ORDER ENTRY PROFILES / SHELF EDGE PROFILES



Clip-on profile ACC AF 75

Application: For special offer signs up to 74 mm in label height.

Art. no.	Length
8351071	210 mm
8351072	105 mm

Height: 74 mm
 Thickness: 0.7 mm
 Material: PVC
 Color: Transparent

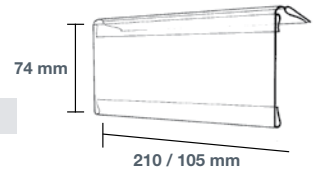

Also available for the following label heights on request:

Quantity per unit: 25

40 ● 65 ● 94 ●



Shelf edge profile holder for Linde cooling shelves

Application: Attachment clip for shelf edge profile on Linde cooling shelf (9134551).

Art. no.: 9134691

Length: 20 x 15 mm
 Material: Polyamide
 Color: White

Quantity per unit: 160



Hang tabs, self-adhesive

Application: Self-adhesive PVC eyelets with delta holes for peg hooks, for retrofitting or as a replacement for torn peg hook holes. For products up to 200 g.

Art. no.: 9406120

Format: 41 x 31 mm
 Material: PVC
 Color: Transparent

Quantity per unit: 50 (5 x 10)

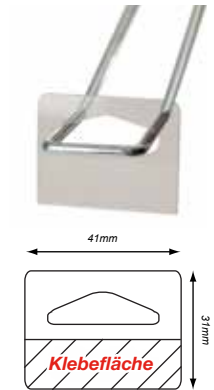

Shelf stopper clip

Application: Plastic clip for attaching special offer signs directly to the shelf, to the product against the direction of customer flow. For attaching signs with standard perforation. Customised shelf-stoppers available on request.

Art. no.	Size	Profile height
9217919	40.5 x 30 x 26 mm	40 mm

Material: Polycarbonate
 Color: Transparent



Quantity per unit: 100



CUSTOMIZED SOLUTIONS

METO PRODUCTS – UNIVERSAL OR CUSTOMIZED TO SUIT YOUR NEEDS

In addition to the standard solutions shown in this catalogue, we also produce your special tailored products volume based.

Sonderpreis
Reduziert
AKTION
Setpreis
Hauspreis
Unser Preis
NEU
Stückpreis
Sonderpreis
H
In



Hand labeler

Printbands / printband sets for individual printing.
Special engraved side flash stickers.



Labels

Customer-specific pre-print in accordance with the METO color chart (Pantone colors) or with your company colours.

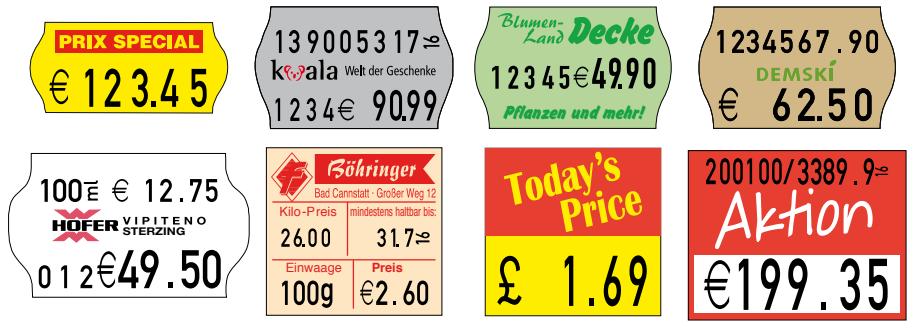

Printing, cutting and bending plastic

Shelf crowners, customer stoppers, transparent poster covers for ceilings and shelves, protective covers, PVC fixings for price cassettes / price displays, acrylic stands and pre-print on shopping baskets.



Due to our policy of continual development, we reserve the right to change any of the specifications contained in this catalogue without notice.

The print colours shown in the labels chapter are not binding. Please refer to our METO colour chart for the original label and pre-print colours.

METO[®]



METO headquarter Hirschhorn/Neckar · Production, management, warehouse

METO®, a business unit of CCL Industries Inc., offers the global retail sector a great variety of innovative and highly cost-efficient labeling and sales promotion solutions. These include in-store communication and advertising, shelf management, merchandise identification and labeling and shopping convenience.

Over the past 55 years, METO has invented an ongoing succession of sales promotion and merchandise labeling solutions which define today's standard practice in the retail sector. METO develops solutions which are easy to handle and set up. As such, these solutions meet the requirements of a retail sector which faces constant change and which operates according to the motto: time is money. Solutions from METO help to ensure effective communications in all areas from pricing through advertising to information on product origin, use-by dates or other details which play a role in the sale of merchandise.

METO combines quality with durability and inspires retailers to communicate with their customers in an effective manner.

METO's success is due in part to its close cooperation with retailers, service providers and industry. These partnerships enable us to continue developing innovative concepts for our customers.

CHECKPOINT SYSTEMS
INTERNATIONAL GMBH
Ersheimer Straße 69
D-69434 Hirschhorn
Tel.: +49 (0)62 72-928-0
Fax: +49 (0)6272-928-204
meto-info@meto.com

The METO catalogues as an app:

for IOS



for Android

